



DIGNO[®] ケータイ **カメラレス**

KY-43C

INSTRUCTION MANUAL

Introduction

Thank you for purchasing "KY-43C".

Be sure to read this manual before and during use to ensure proper operation.

About manuals

Quick Start Guide (bundled) (in Japanese only)

This guide describes basic operations.

"Instruction Manual" application (installed in the handset) (in Japanese only)

This manual describes detailed guidance and operations of functions.

You can search by free word, open the setting screen or launch the application from the displayed page, etc. Use the handset more conveniently with this application.

[Using method]

In the standby screen,  ► [Tools] ► [Instruction Manual]

Instruction Manual (in PDF format)

This manual describes detailed guidance and operations of functions.

Download from the NTT DOCOMO website.

NOTE

- "KY-43C" is referred to as "handset" in this manual.

- The explanations in this manual are based on the handset at time of purchase.
- Handset is subject to version updates of the operating system (OS) to enhance quality and functionality. These may change how to operate handset. For details on added functions and changes to operation, refer to the NTT DOCOMO website. Older versions of apps may no longer be usable, or unintended issues may occur.
- Some applications or services are not available depending on your contract detail. For details, refer to the NTT DOCOMO website.
- Contacts to NTT DOCOMO vary depending on your contract detail. For details, see the back cover of this manual.
- In this manual, the explanations and screen images for handset color "Black" are provided.
- The contents of this manual as well as the website URL are subject to change without prior notice.
- The screens and illustrations in this manual are shown as examples. Actual screens and illustrations may differ.
- Reproduction of this manual in part or in whole without prior permission is prohibited.
- This manual refers to microSD card or microSDHC card as "microSD card" or "microSD".
- Key illustrations in this manual may differ in typeface or shape from actual keys, or may be partially omitted.

Handset and bundled accessories



KY-43C

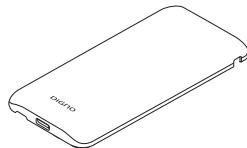

Back Cover KY03

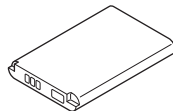

Battery Pack KY01

Quick Start Guide (in Japanese only)

- You can also check and purchase optional accessories (sold separately) compatible with the handset at the NTT DOCOMO Online Shop.
<https://onlineshop.smt.docomo.ne.jp/options/search.html> (in Japanese only)

Contents

Using the handset	4
Precautions (ALWAYS FOLLOW THESE DIRECTIONS)	5
Handling precautions	17
Water, Dust, & Shock Resistance.....	23

Before Using the Handset

Part names and functions.....	30
Basic operation	33
nano SIM card.....	41
microSD card.....	45
Battery pack.....	47
Charging.....	48
Powering on/off.....	52
Device Control application	52
Text entry	52
Initial settings.....	57
Managing tasks	58
Using the custom keys	59

Calling

Making a call	60
Answering a call.....	63
Operations during a call.....	65
Redial/incoming history.....	66

Voice memo/answering memo	67
Call log/call settings.....	68
Phonebook	71

Mail/web browser

docomo mail	75
+Message	78
PC mail	82
Web browser.....	86

Tools/Apps

Calendar	90
Calculator	91
Alarm	91
Countdown timer.....	93
Stopwatch.....	93
World clock.....	93
Notepad.....	94
Sound recorder	94
Weather.....	95
Kanji check.....	96
OfficeSuite	96
SD card backup.....	96
Data backup service.....	98
Data switch	98
Device Control	98

Handset Settings

Settings menu	101
Wallpaper/Display	101
Sound/Notification	102
Lock/Security	104
Wireless/Network	108
docomo service	114
Battery	114
Handset Information (About Phone)	115
More Settings	115

Data Management

Handset memory (internal storage)	121
microSD card (external storage)	121
Working with files	121
PC connection	123

Data Transfer

Bluetooth® transfer	125
---------------------------	-----

Safety and Security Services

Disaster message board	128
Early warning "Area Mail"	128
Anshin Security	130
Anshin Filter	131

Overseas use

Outline of international roaming (WORLD WING)..	132
Available services for overseas	132
Before using the handset overseas	132
Making/Receiving a call in the country you stay..	134
Setting international roaming	136
After returning to Japan	138

Appendix/Index

Handset menus	139
Troubleshooting (FAQ)	142
Warranty & after-sales service	147
Software updates	150
Main specifications	152
Specific Absorption Rate (SAR) Information of Mobile Phones	154
FCC Notice	155
Export Control Regulations	157
Intellectual property rights	157
Index	161



Using the handset

- The handset supports LTE, W-CDMA, GSM/GPRS and Wireless LAN Systems and SIM lock is disabled.
- Because the handset relies on radio signals, it cannot be used in a place with no signal (such as tunnels, underground or in buildings), in places with a weak signal or outside the LTE service area. You may not use the handset in the upper floors of a building even with no obstructions in sight. There may also be times when the signal is strong and you are not moving but the call is interrupted.
- Because the handset uses radio waves, it is possible for a third party to listen in on a conversation. However, since the LTE, W-CDMA, and GSM/GPRS systems automatically apply a private call feature to every call, a third party that tries to listen in only hears noise.
- The handset converts conversations into a digital signal and sends it to the other party over the radio. If the signal cannot be reconverted properly by such as moving to an area with a weak signal, the voice may not be heard correctly.
- Take notes of data stored on the handset or save the data to external memory devices such as microSD cards and PCs periodically. DOCOMO shall not be liable whatsoever for any loss of content due to a failure, repair, model change or other handling of the handset.
- Verify the supplier and operating conditions of applications, sites, etc. to be used before using them. Some applications that you install or websites that you access may disrupt the stability of handset performance or unexpectedly transmit information via the Internet causing improper use of your location information, personal information, etc.
- The handset automatically performs communication for some functions, for example, to synchronize data, check the latest software version or maintain connection with the server. Also, large-volume data communication such as watching videos will lead to higher packet communication charges.
- When making initial settings, some applications provided by DOCOMO may be installed automatically. If you use mobile network at this time, packet communication charge may be applied. For automatic selection of the applications to install, DOCOMO infers the customer's needs based on the information that the customer has provided to DOCOMO with the prior consent of the customer or other customer's information DOCOMO has retained. Handling the customer information is properly managed in compliance with the terms of DOCOMO privacy policy.
- Depending on the apps or services you are using, packet communication charges may be incurred even while using Wi-Fi.
- When the available space on the microSD card or the handset is insufficient, apps in use may not work properly. In this case, delete saved data.

- Ensure the security of your handset by setting a screen lock password in case you lose it (→P.104).
- If terms of use appear, follow the instructions on the screen.
- Apps and their service contents are subject to change without prior notice.
- The handset does not support providers other than sp-mode, mopera U and Business mopera Internet.
- For details on usage fee, refer to the NTT DOCOMO website.
- The handset display is manufactured using high-precision technology, but it may contain dots that fail to light or that remain permanently lit on some areas. This is a characteristic of the display and not a malfunction.
- Note that DOCOMO shall not guarantee operation of commercially available optional accessories.

Precautions (ALWAYS FOLLOW THESE DIRECTIONS)







- Before use, read these "Precautions" carefully and use your handset properly.
- These precautions contain information intended to prevent bodily injury to the user and to surrounding people, as well as damage to property, and must be observed at all times.
- The following symbols indicate the different degrees of injury or damage that may occur if information provided is not observed and the handset is used improperly.

 DANGER	This sign denotes that "death or serious injury (*1) may directly result from improper use".
 WARNING	This sign denotes that "death or serious injury (*1) may result from improper use".
 CAUTION	This sign denotes that "minor injury (*2) or damage to property (*3) may result from improper use".

- *1 Serious injury: This refers to loss of sight, injury, burns (high- and low-temperature), electric shock, broken bones, poisoning, etc. with remaining aftereffects, and injuries requiring hospital admission or long-term hospital visitation.

- *2 Minor injury: This refers to injuries, burns (high- and low-temperature), electric shock, etc. that do not require hospital admission or long-term hospital visitation.
- *3 Damage to property: This refers to extended damage to buildings, furniture, livestock, pets, etc.

■ The following symbols indicate specific directions.

	Denotes things not to do (prohibition).
Don't	
	Denotes not to disassemble.
No disassembly	
	Denotes not to use where it could get wet.
No liquids	
	Denotes not to use with wet hands.
No wet hands	
	Denotes mandatory instructions (matters that must be complied with).
Instruction	
	Denotes that the equipment should be unplugged.
Unplug	

1. Handling the handset, battery pack, adapters, and nano SIM card (common)

DANGER



Don't

Do not use, store or leave the equipment in locations subject to high temperatures or where heat collects (near a fire or heating unit, in a kotatsu or futon, under direct sunlight, inside a vehicle on a hot day, etc.). May cause fire, burns, injury, electric shock, etc.



Don't

Do not place the equipment inside or near cooking appliances such as microwave ovens, IH cooktops, or pressure cookers. May cause fire, burns, injury, electric shock, etc.



Don't

Do not expose to or place directly on sand, dirt, or mud. Do not handle with dirty hands. May cause fire, burns, injury, electric shock, etc. Refer to the following for details on waterproofness/dustproofness.
→P.23



Don't

Do not charge the equipment when wet with water or other liquid (beverage, sweat, seawater, pet urine, etc.). Do not charge where exposed to water (bathroom, near a humidifier, etc.). May cause fire, burns, injury, electric shock, etc. Refer to the following for details on waterproofness.
→P.23



Don't

Do not subject the handset to strong pressure or break the handset. Especially when carrying it in your pocket, do not hit it or press it between other objects.

May cause fire, burns, or injury due to battery damage.

* Examples to avoid

- Sitting or squatting with handset in your pants or skirt pocket
- Handset becoming caught in a sliding door or vehicle door when in a jacket pocket
- Stepping on the handset when it is on something soft such as a sofa, bed, or bedding, or on a floor
- Handset becoming caught in a seat on a train or bus



No disassembly

Do not attempt to disassemble or modify the equipment.

May cause fire, burns, injury, electric shock, etc.



No liquids

Do not get the equipment wet with water or other liquid (beverage, sweat, seawater, pet urine, etc.).

May cause fire, burns, injury, electric shock, etc.

Refer to the following for details on waterproofness.

→P.23



No liquids

Do not allow water or other liquid (beverage, sweat, seawater, pet urine, etc.) to get inside the external connector terminal.

May cause fire, burns, injury, electric shock, etc.

Refer to the following for details on waterproofness.

→P.23



Instruction

Use optional accessories specified by NTT DOCOMO.

Using products other than those specified or those with unclear manufacturer, distributor, or specifications may cause fire, burns, injury, electric shock, etc.

WARNING



Don't

Do not subject the equipment to strong force, impact, or vibration by dropping it, stepping on it, or throwing it.

May cause fire, burns, injury, electric shock, etc.



Don't

Do not allow conductive materials (such as metal objects or pencil lead) to come into contact with the external connector terminal, or dust to enter them.

May cause fire, burns, injury, electric shock, etc.



Don't

Do not cover or wrap the equipment with bedding, etc. during use or while charging.

May cause fire, burns, etc.



No liquids

When caring for equipment, ensure that no disinfectant or water enters the external connector terminal, earpiece/speaker, or mouthpiece/microphone.

Handset breakage may cause injury, electric shock, etc.



Instruction

If charging does not complete after the specified charging time, discontinue charging.

Overcharging may cause fire, burns, injury, etc.



Instruction

Always power off handset or stop charging before entering anywhere flammable gas or dust may be generated.

May ignite flammable gases, etc. and cause explosion, fire, etc.



For use at a gas station or similar location, follow the instructions of the facility.

Instruction

Do not charge at a gas station or similar location. If using at a gas station or similar location, be careful not to drop, and in particular, do not use while filling.
May ignite flammable gases, etc. and cause explosion, fire, etc.



If there is abnormal odor/sound, smoke, overheating, discoloration, distortion, or other abnormalities during use, charging, or storage, do the following while exercising caution.

Instruction

- Unplug the power plug from the outlet or accessory socket.
- Turn off the handset.
- Remove the battery pack from the handset.

Continued use may cause fire, burns, injury, electric shock, etc.

CAUTION



Do not use damaged equipment.

Don't

May cause fire, burns, injury, etc.



Do not leave the equipment on unstable surfaces, such as on a wobbly table or sloped surface. In particular, be careful while handset is set to vibrate.

Don't

May fall and cause injury, etc.



Don't

Do not store or use the equipment in locations that are subject to humidity, dust, or high temperatures.

May cause fire, burns, electric shock, etc.
Refer to the following for details on waterproofness/dustproofness.
→P.23



Don't

If being used by a child, a guardian should show them the proper way to handle equipment, and do not allow improper use.

They may swallow parts, or may cause injury, electric shock, etc.



Don't

Do not leave the equipment in the reach of infants or pet animals.

They may swallow parts, or may cause injury, electric shock, etc.



Instruction

Note that equipment may become warm if handset is used for a continued period or while charging. Be careful not to have unintended, continued contact with equipment such as by falling asleep with equipment in pocket, etc.

The handset, battery pack, or adapter may become warm if you use apps, calling, or data communication, or watch video or TV, etc. continuously or while charging. Directly touching hot parts continuously may cause redness, itchiness, rash, low-temperature burns, etc. depending on the individual. Be careful when you put the handset in a pocket of clothes, when you sleep, etc.

2. Handling the handset

DANGER



Don't

Do not throw the handset into a fire or heat it.
May cause fire, burns, injury, etc.



Don't

Do not apply excessive force to the handset such as by puncturing it (sharp object), hitting it (hard object), or stepping on it.
May cause fire, burns, injury, etc.



Instruction

If substance in the handset gets in your eyes, mouth, etc., rinse with clean water and consult a doctor immediately.

Substances in handset may cause loss of sight or other physical harm.

WARNING



Don't

Do not view a repeatedly flickering screen for a prolonged period.
May cause convulsions, loss of consciousness, etc.



Don't

Do not allow water or other liquids (beverage, sweat, seawater, pet urine, etc.), metal (cutter blades, staples, etc.), flammable material, or other foreign objects to enter the nano SIM card slot or microSD card slot on the handset.
Note the correct locations and orientations for inserting the nano SIM card and microSD card.
May cause fire, burns, injury, electric shock, etc.



Instruction

Turn off the handset or set it to Airplane mode before going aboard an airplane.

Use of handset on board an aircraft is restricted. Follow instructions of the airline. Radio waves may adversely affect an aircraft's electronic devices. Prohibited use aboard an aircraft may be subject to penalty by law.



Instruction

For use at a hospital, follow the instructions of the institution.

Turn off the handset in areas where the use of mobile phones is prohibited. May interfere with the operation of electronic devices and electronic medical devices.



Instruction

When you are on a handsfree call, while ringtone is playing loudly, when in standby, etc., be sure to keep handset at a safe distance from your ears.

Adjust to an adequate volume when using earphones with microphone or similar accessory to play games or play back videos/music.

When making a handsfree call, handset emits sound loudly.

Even in standby, the ringtone or alarm may ring suddenly.

Listening to loud sound continuously for a long time may cause hearing impairment or other difficulty.

In addition, not being able to hear surroundings may cause an accident.



Instruction

Users with a heart condition should adjust vibration and ringtone volume as needed.

Handset suddenly vibrating and ringing for a new call may startle and affect persons with heart conditions.



Instruction

If wearing an electric medical device or similar apparatus, check with the manufacturer or vendor regarding any effect that radio waves may have on it.

Radio waves may adversely affect electronic medical devices, etc.



Instruction

Power off handset near electronic devices that use precision control or faint signals.

Radio waves may cause electronic devices to malfunction or may adversely affect operation.

* Take particular care with the following devices
Hearing aids, implanted cardiac pacemakers, implanted cardioverter-defibrillators, other electronic medical devices, and other automatically controlled devices or equipment. If you are using an implanted pacemaker, implanted defibrillator, or other electronic medical device, check with the manufacturer or vendor regarding any effect that radio waves may have on it.



Instruction

If the display is damaged, be careful of broken parts and the exposed inside of the handset.

Touching the broken or exposed parts may cause burns, injury, electric shock, etc.

CAUTION



Don't

Do not swing the handset by its strap, etc.

May cause an accident such as injury.



Don't

If display breaks and substance in the handset leaks, do not let it get on your skin (face, hands, etc.) or clothes.

May harm your eyes, skin, etc.

If substance in the handset gets in your eyes, mouth, etc. or on your skin or clothes, immediately rinse with clean water.

If it gets in your eyes, mouth, etc., rinse and immediately consult a doctor.



Don't

Do not use more force than necessary to remove the back cover.

May break the back cover and cause injury, etc.



Don't

Avoid pinching your fingers or other part of yourself when attaching the back cover.

May cause injury, etc.



Don't

Do not use the handset with the back cover removed.

May cause burns, injury, electric shock, etc.



Instruction

Before using the handset in a car, check with the car manufacturer or dealer regarding any effect that radio waves may have on it.

May interfere with the operation of electronic equipment in some vehicle models. In this case, stop using the handset. Immediately stop handset use.



Instruction

If use of the handset causes any skin abnormalities, immediately stop using the handset and seek medical treatment.

Handset use may cause itchiness, skin irritation, rashes, etc. depending on your physical condition. Refer to the following for details on materials of each part.

→P.15



Instruction

Avoid pinching your fingers or other part of yourself when opening or closing the handset.

May cause injury, etc.



Instruction

Handset earpiece/speaker (including at exterior case) uses magnetic components. Make sure that no metal objects (cutter blades, staples, etc.) are attached to the handset.

Attached objects may cause injury, etc.



Instruction

View the display in a well-lit place at an adequate distance.

Viewing in a dark location or too closely may affect your eyesight.

3. Handling the battery pack

DANGER



Don't

Do not touch connection terminals with anything metal or conductive (necklaces, hairpins, etc.). In addition, do not carry or store the battery pack with such objects. May cause fire, burns, injury, etc.



Don't

If you are having difficulty fitting the battery pack to the handset, do not use excessive pressure to force the battery into place. If you are having difficulty removing the battery pack from the handset, do not use excessive pressure to force the battery out. May cause fire, burns, injury, etc. Refer to the following for details about fitting/removing the battery pack. →P.47



Don't

Do not throw the handset into a fire or heat it. May cause fire, burns, injury, etc.



Don't

Do not apply excessive force to the handset such as by puncturing it (sharp object), hitting it (hard object), or stepping on it. May cause fire, burns, injury, etc.



Instruction

Check the orientation of the battery pack before installing it in the handset.

Installing the battery pack in the wrong orientation may damage it and cause fire, burns, injury, etc. Refer to the following for details about fitting the battery pack. →P.47



Instruction

If substance in the battery pack gets in your eyes, mouth, etc., rinse with clean water and consult a doctor immediately.

Substance in the battery pack may cause loss of sight or other physical harm.

WARNING



Don't

If there is anything unusual such as odor, overheating, discoloration, deformation, etc., do not use the battery pack. May cause fire, burns, injury, etc.



Instruction

If the battery pack leaks or emits an unusual odor, immediately stop using it and move it away from any naked flames or fire. Leaking fluid may ignite, causing fire, rupture, etc.



Instruction

Prevent pets from biting the battery pack. A damaged battery pack may cause fire, burns, injury, etc.

CAUTION



Don't

If substance in the battery pack leaks, do not let it get on your skin (face, hands, etc.) or clothes.

May harm your eyes, skin, etc.

If substance in the handset gets in your eyes, mouth, etc. or on your skin or clothes, immediately rinse with clean water.

If it gets in your eyes, mouth, etc., rinse and immediately consult a doctor.



Don't

Do not dispose of battery packs together with ordinary trash.

May cause fire, burns, injury, etc. May also adversely affect the environment. Place tape over the terminals on old battery packs to insulate them, and take them to a sales outlet such as a docomo Shop or follow municipal instructions for recycling.



Don't

Do not use or charge a wet battery pack.

May cause fire, burns, injury, etc.

4. Handling adapters

WARNING



Don't

Do not use if the cord of the adapter is damaged.

May cause fire, burns, electric shock, etc.



Don't

DC adapters are only for use with minus-earth vehicles. Do not use with plus-earth vehicles.

May cause fire, burns, electric shock, etc.



Don't

Do not touch adapters if you hear thunder.

May cause electric shock, etc.



Don't

Do not short-circuit the charging terminal when connected to an outlet or accessory socket. Do not allow any part of yourself (hands, fingers, etc.) to come in contact with the charging terminal.

May cause fire, burns, electric shock, etc.



Don't

Do not place heavy objects on the cord of the adapter or apply excessive force such as by pulling.

May cause fire, burns, electric shock, etc.



Don't

When plugging/unplugging an AC adapter, keep any metal strap, etc. away.

May cause fire, burns, electric shock, etc.



Don't

Do not use a voltage converter (travel converter for overseas use, etc.) when charging with an AC adapter.

May ignite, overheat, cause electric shock, etc.



Don't

Do not apply excessive force where the adapter is connected to the handset.
May cause fire, burns, injury, electric shock, etc.



No wet hands

Do not handle the cord or charging terminal of the adapter, the power plug, or a desktop holder with wet hands.
May cause fire, burns, electric shock, etc.



Instruction

Always use the specified power supply and voltage. Also, use an AC adapter for global use when charging abroad.

Using the incorrect power supply or voltage may cause fire, burns, electric shock, etc.

AC adapter: 100 V AC (household AC power outlet only)

AC adapter for global use: 100 V to 240 V AC (household AC power outlet only)

DC adapter: 12 V/24 V DC (only for use with minus-earth vehicle)



Instruction

Always use a specified fuse when replacing a fuse in a DC adapter.

Using unspecified fuses may cause fire, burns, electric shock, etc. See individual instructions regarding specified fuses.



Instruction

Wipe off any dust on the power plug.

Using while dusty may cause fire, burns, electric shock, etc.



Instruction

Insert the power plug of the adapter in the outlet or accessory socket firmly.

Failure to do so may cause fire, burns, electric shock, etc.



Instruction

When unplugging from an outlet or accessory socket, grasp the adapter body and do not pull the cord or otherwise subject it to excessive force.

Pulling the cord of the adapter may damage it and cause fire, burns, electric shock, etc.



Instruction

Insert or remove the connector of the adapter in/from the handset without bending or applying force such as pulling the cord.

Not inserting/removing it correctly may cause fire, burns, injury, or electric shock.



Instruction

Cease using the adapter immediately if the charging terminal is bent or otherwise deformed. Also, do not repair the charging terminal to use the adapter.

Short-circuiting of the charging terminal may cause fire, burns, injury, electric shock, etc.



Unplug

When not in use, unplug from the outlet or accessory socket.

Leaving it plugged in may cause fire, burns, electric shock, etc.



Unplug

If splashed with water or other liquid (beverage, sweat, seawater, pet urine, etc.), immediately unplug from the outlet or accessory socket.

May cause fire, burns, electric shock, etc.



Unplug

Always unplug the power plug from the outlet or accessory socket before cleaning the equipment.

Cleaning while still plugged in may cause fire, burns, electric shock, etc.

CAUTION



Don't

Do not touch an adapter continuously when connected to an outlet or accessory socket. May cause burns, etc.

5. Handling the nano SIM card

CAUTION



Be careful not to scratch yourself (finger, etc.) with the edges when handling the nano SIM card.

Instruction Edges may be sharp and cause injury.

6. Handling near electronic medical devices

WARNING



Instruction

If you have an electronic medical device such as an implanted cardiac pacemaker or an implanted cardioverter-defibrillator, always carry or use your handset at least 15 cm away from your implant.

Radio waves may adversely affect operation of electronic medical devices.



Instruction

When using electronic medical equipment (other than implanted cardiac pacemakers/defibrillators) outside medical facilities, check with the equipment vendor or distributor for information about the effects of radio waves. Radio waves may adversely affect operation of electronic medical devices.



Instruction

Disable handset transmissions (e.g. airplane mode) or power off handset when it is difficult to keep a distance of at least 15 cm away from others such as in a crowd.

Someone nearby may be wearing an electronic medical device such as an implanted cardiac pacemaker or an implanted cardioverter-defibrillator. Radio waves may adversely affect operation of electronic medical devices.



Instruction

Observe a medical facility's instructions when using handset.

Radio waves may adversely affect operation of electronic medical devices.

7. Material list

■ Handset

Part	Material	Surface treatment
Outer case (Key case, LCD front case)	PC + GF plastic	Acrylic UV hardening coating

Part	Material	Surface treatment
Outer case (hinge cover)	PC plastic	Acrylic UV hardening coating
Outer case (LCD rear plate)	PMMA resin (molded-in)	Acrylic UV hardening foil
Manner key	PC plastic	Acrylic UV hardening coating
Phonebook/up key, down key, center key, call history/left key, redial/right key, menu key, mail key, voice/answering memo key, browser key, call key, clear key, power/end key, dial keys, customize keys (I, II, III), cushion	PET plastic	UV curing
Window panel (main)	PMMA plastic	Hard coating
Window panel (sub)	PMMA resin (molded-in)	Acrylic UV hardening foil
Internal main antenna area, internal subantenna area	PC plastic	Gold plating (element)
Screws	Iron	Nickel plating

Part	Material	Surface treatment
Rubber gasket	Silicone plastic	—
Stopper	PP plastic	—
Card slot (nano SIM/microSD)	SUS	—
Sticker	PET plastic	—
Terminals	Copper	Gold plating (nickel base plating)

■ Back Cover KY03

Part	Material	Surface treatment
Outer case	PC plastic	Acrylic UV hardening coating

■ Battery Pack KY01

Part	Material	Surface treatment
Exterior	PC plastic	—
Sticker	PET (base) + PP (surface)	—
Terminals	Copper	Gold plating (nickel base plating)

Handling precautions

General notes

- **KY-43C is water resistant/dust resistant, however, do not allow water or other liquid (beverage, sweat, seawater, pet urine, etc.) or dust or other matter to get inside the handset or to remain on bundled or optional accessories.**

The battery pack, adapter, and nano SIM card are not waterproof/dustproof. Do not use in humid or steamy areas such as bathrooms and avoid exposing to rain and other forms of moisture. If they are carried on you, perspiration may cause internal components to corrode and result in malfunction. Note that if a problem is found to be due to moisture, handset and parts repair will not be covered by warranty. For repairs, see "Warranty & after-sales service" (→P.147).

- **Clean the terminals, etc. from time to time to maintain them in clean condition.**

Use in a soiled condition may prevent normal use. Avoid damaging terminals when cleaning.

- **Do not place the equipment near an air conditioning vent.**

Condensation from rapid changes in temperature may cause internal corrosion and lead to a malfunction.

- **Do not apply excessive force to the handset, battery pack, etc. when using them.**
Placing in a bag or other storage where many other things are stuffed, or carrying in a pocket and sitting down can cause display, internal circuitry, battery pack, etc. to malfunction or break.
May also cause malfunction or damage while an external device is connected to the external connector terminal.
- **Use optional accessories specified by NTT DOCOMO.**
Using unspecified accessories may cause malfunction or damage.
- **See individual instructions included with compatible optional accessories.**
- **Do not drop or subject to impact.**
May cause malfunction or damage.

Notes about the handset

- **Wipe clean with a dry, soft cloth (such as for eye glasses).**
 - Wiping forcefully may scratch the display.
 - Allowing moisture or smudges to remain on the display may leave blemishes.
 - Wiping with thinner, benzine, detergent, etc. may remove print or fade colors.

- The handset can be wiped with a disinfectant alcohol sheet or cloth containing a small amount of alcohol (such that the cloth is dampened). The handset has been wipe-tested with the following chemicals used commonly in disinfectant alcohol sheets to test its chemical resistance.
(1) Isopropyl alcohol, (2) ethanol, (3) sodium hypochlorite
No noticeable discoloration or fading was confirmed in testing assuming wiping with disinfectant alcohol sheets. However, handset resistance is verified under test conditions, and complete non-occurrence of discoloration or fading is not guaranteed.
- **Do not press or scratch the display forcibly.**
May scratch the display, causing malfunction or damage.
- **Avoid using the handset in extremely high or low temperatures.**
Use the handset within a temperature range of between 5° C and 35° C and a humidity between 35% and 85%.
- **Use near an electronic appliance (TV, radio, etc.) may cause interference. Distance the handset as much as possible.**
- **Be sure to back up the data you saved in the handset to a microSD card or PC, or make a separate note.**
DOCOMO is not responsible for any saved data that is lost.

- **When connecting an external device to the external connector terminal, avoid inserting at an angle, and avoid pulling while connected.**
May cause malfunction or damage.
- **Do not close the handset on strap, etc.**
May cause malfunction or damage.
- **The handset may become warm while in use or charging, but is normal. Continue use/charging.**
- **Do not use the handset with the back cover removed.**
The battery pack may come out, or it may cause malfunction or damage.
- **Do not cover the surface of the display or keys with an extremely thick sticker or label.**
The sticker or label may catch when opening or closing the handset, and may cause malfunction, damage, or misoperation.
- **While handset is accessing the microSD card, do not remove the card or power off the handset.**
May cause data to be erased or may cause malfunction.
- **Do not place magnetic stripe cards or magnetic objects near or closed in the handset.**
Information saved on cash cards, credit cards, commuter IC cards, etc. may be erased.
A strong magnetic field may also cause the handset to malfunction.

Notes about battery pack

- Always charge where at an appropriate temperature (5° C to 35° C).
- Battery life depends on the usage and deterioration of the battery pack.
- Since the battery pack is a consumable accessory, it is not under warranty.

Depending on usage, the battery pack may bulge as it approaches the end of its service life.

Replace if operating time shortens noticeably even after charging or if it bulges. For replacement of the battery pack, see "Warranty & after-sales service" (→P.147).

- To help maintain performance and life of the battery pack, do not store the battery pack in the following conditions.
 - Full (immediately after charging is complete)
 - Exhausted (too low to power on the handset)Optimal battery level for storage is 40 percent.
- Battery pack is the following type.

Indication	Battery type
Li-ion OO	Lithium-ion battery

- Wipe clean with a dry, soft cloth (such as for eye glasses).

Wiping with thinner, benzene, detergent, etc. may remove print or fade colors.

Notes about adapters

- Always charge where at an appropriate temperature (5° C to 35° C).
- Do not charge in these locations.
 - Where there is much humidity, dust, or vibration
 - Near an electronic device (TV, radio, etc.)
- An adapter may become warm while charging, but is normal. Continue use/charging.
- If charging using a DC adapter, do not use with the vehicle's engine turned off.
May drain the vehicle's battery.
- If using an outlet with a protector to prevent unplugging, follow the instructions for the outlet.
- Do not subject to strong impact. Do not deform the charging terminal.
May cause malfunction.
- Wipe clean with a dry, soft cloth (such as for eye glasses).
Wiping with thinner, benzene, detergent, etc. may remove print or fade colors.

Notes about the nano SIM card

- Do not apply unnecessary force when inserting/removing the nano SIM card.
- Customer is responsible for malfunction caused by use after having inserted the nano SIM card in an other-brand IC card reader/writer, etc.

- Clean the IC area from time to time to maintain it in clean condition.
Use in a soiled condition may prevent normal use.
- Wipe clean with a dry, soft cloth (such as for eye glasses).
- Be sure to back up the data you saved on the nano SIM card to a microSD card or PC, or make a separate note.
DOCOMO is not responsible for any saved data that is lost.
- To protect the environment, take old nano SIM cards to where they are collected such as a docomo Shop.
- Do not scratch, carelessly touch, or short-circuit the IC.
May cause data to be erased or may cause malfunction.
- Do not drop or subject the nano SIM card to impact.
May cause malfunction.
- Do not bend the nano SIM card or place heavy objects on it.
May cause malfunction.
- Do not install the nano SIM card in the handset with a label or sticker on it.
May cause malfunction.

Notes on using the Bluetooth function

- The handset is equipped with Bluetooth-compliant security features for communication via Bluetooth. However, these may be inadequate depending on settings. Be aware when using Bluetooth.
- DOCOMO is not responsible for any information which may be leaked during communication via Bluetooth.
- **Frequency bands**
To check frequencies the handset Bluetooth function uses: In the standby screen, [Settings] ▶ [About phone] ▶ [Compliance information]. Label markings are as follows.

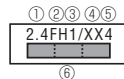

- ① 2.4: Radio equipment using the 2,400 MHz band.
 - ② FH: FH-SS modulation.
 - ③ 1: Expected maximum interference range of about 10 m.
 - ④ XX: Other-method modulation.
 - ⑤ 4: Expected maximum interference range of about 40 m.
 - ⑥ : Utilizes 2,400 MHz to 2,483.5 MHz band without mobile device bandwidth differentiation.
- Use of Bluetooth function is limited in some countries/regions. Confirm regulations of the country/region to use it. Before using aboard an aircraft, check with the airline beforehand.

● Cautions on using Bluetooth devices

The handset uses the same frequency band as used by household appliances such as microwave ovens and industrial, scientific, and medical equipment, (licensed) premises radio stations used to identify mobile units used in manufacturing lines, (unlicensed) specified low-power radio stations, and amateur radio stations (below, "other radio stations").

1. Before using handset, check that other radio stations are not in use nearby.
2. If interference should occur with other radio stations, immediately change handset location or power off the handset to avoid interference.
3. If there is anything you are unsure of, contact the contacts on the back cover.

Notes about wireless LAN (WLAN)

- A wireless LAN (WLAN) exchanges information using radio waves, and allows you to freely establish a LAN connection if you are within an area where radio waves reach. However, communication without appropriate security settings may allow communication to be intercepted by malicious parties. It is recommended to make security settings, and is at your discretion.

- DOCOMO is not responsible for any information which may be leaked during communication via wireless LAN.

● Wireless LAN

Do not use where there are devices with magnetic fields (electrical products, AV/OA equipment, etc.) or where there is an electromagnetic field.

- Magnetic fields may increase electrical noise or may affect communication (especially when using a microwave oven).
- It may interfere with reception if near a TV, radio, etc., or the TV screen may become unviewable.
- If multiple wireless LAN access points using the same channel are in proximity, handset may not detect access points correctly.

● Frequency bands

To check frequencies the handset wireless LAN function uses: In the standby screen,  [Settings] ▶ [About phone] ▶ [Compliance information]. Label markings are as follows.

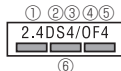

- ① 2.4: Radio equipment using the 2,400 MHz band.
- ② DS: The modulation system is the DS-SS system.
- ③ 4: Expected maximum interference range of about 40 m.
- ④ OF: OFDM modulation.
- ⑤ 4: Expected maximum interference range of about 40 m.

⑥ : Utilizes 2,400 MHz to 2,483.5 MHz band with mobile device bandwidth differentiation.

Available channels vary by countries.

Before using aboard an aircraft, check with the airline beforehand.

● Cautions on using 2.4 GHz devices

WLAN devices use the same frequency band used by household appliances (microwave ovens) and industrial, scientific, and medical equipment as well as by premises radio stations (requiring a license) and specific low-power radio stations (not requiring a license) for mobile identification as used in production lines, and by amateur radio stations (requiring a license).

1. Before using the handset, check that no premises radio stations for mobile identification, specific low-power radio stations, or amateur radio stations are in operation nearby.
2. If use of the handset causes interference with regard to an in-place radio stations for mobile identification, immediately change the usage frequency, or discontinue use, then contact the contacts on the back cover and ask about ways to avoid interference (putting a partition in place, etc.).
3. If the handset is otherwise a cause of interference with regard to specific low-power radio stations for mobile identification or amateur radio stations and assistance is required, contact the contacts on the back cover.

Caution

- **Never use the handset if modified. Using the handset if modified is a violation of the Radio Law and the Telecommunications Business Law.**

The handset has received certification of compliance with technical standards as a specific wireless device based on the Radio Law as well as compliance with technical standards as a device based on the Telecommunications Business Law, indicated by the "technical conformity mark " on its electronic nameplate. To check the electronic nameplate:

In the standby screen,  ► [Settings] ► [About phone] ► [Compliance information].

Removing handset screws and modifying the handset voids technical conformity certification.

Using handset with its certification voided is a violation of the Radio Law and the Telecommunications Business Law. Never use with certification voided.

- **Be careful of using the handset while driving a vehicle.** Other than where excepted by law, looking at handset screen or taking the handset in your hand to talk while driving are subject to prosecution.
- **Do not change the base software without authorization.** This is regarded as software modification, and the handset may be refused for malfunction repair.

Water, Dust, & Shock Resistance

KY-43C is water resistant to IPX5*1, IPX8*2 and dust resistant to IP5X*3 standards if the back cover is attached. The handset also has shock resistance compliant with MIL standards*4 (Kyocera testing methods).

- *1 IPX5: handset retains phone functioning after being subjected to a jet flow (12.5 L/min) discharged from a nozzle (inner diameter: 6.3 mm), from all directions (approximately 3 m from the handset) for 3 minutes or more.
- *2 IPX8: handset experiences no seepage and retains phone functioning after it is slowly submerged to depth of 1.5 m in standing tap water at room temperature, left there for approximately 30 minutes and then taken out.
- *3 IP5X: handset continues to function as a phone and maintains its safety after being agitated in a test device with 75 µm or smaller particles for 8 hours. (Does not completely block ingress of particles.)
- *4 MIL standards
Drop testing in which the product is dropped in 26 directions from a height of 1.22 m onto steel plate conducted in accordance with MIL-STD-810H Method 516.8: Shock-Procedure IV defined by the U.S. Department of Defense.
* Shock resistance assumes usual everyday use. The handset may break if subjected to excessive shock such as being thrown or dropped forcibly. Even if handset continues to function normally, dropping it may cause scratches, etc.

- Operation is not guaranteed for all conditions. Warranty does not cover malfunctions resulting from misuse.

What KY-43C water and dust resistance allows it to do

- You can call without using an umbrella in the rain (for rainfall of approximately 20 mm per hour).
- You can rinse off dirt from the handset. Wash the handset with low-pressure water flow (6 L/min or less tap water at room temperature (5° C and 35° C)), holding it approximately 10 cm below faucet or shower head. Wash by using only your hands, not a brush or sponge, with the back cover attached. Drain the handset before use (→P. 28).
- You can use the handset at a poolside. Do not splash pool water on the handset or submerge the handset in the pool.

Precautions before use

- Be sure the back cover is complete attached. The handset is water resistant when the back cover is secured completely.
- Never open or close the back cover while hands or the handset is wet.
- Do not immerse or expose the handset to liquids other than water (alcohol, seawater, pool water, hot spring water, soap, detergent, water with bath salts, drink, alcohol beverage, food seasoning, etc.). Also do not use where exposed to pet urine.
If exposed, immediately rinse with tap water.

- Do not place directly on a sandy beach, etc. Sand in earpiece/speaker, mouthpiece/microphone, air pressure hole, or external connector terminal may affect sound, and sand entering the handset from hinges, etc. may cause overheating or malfunction.
- Do not use under water.
- Do not use or store for a prolonged period in a bathroom, kitchen, or other humid place.
- Moisture may remain after draining. This does not affect the handset, however, do not place the handset near items you do not want to become wet. Use care, as it can cause wetting inside clothing or a bag.
- Drain any moisture that has collected in the earpiece/speaker, mouthpiece/microphone, air pressure hole, or external connector terminal and is causing sound to be inaudible.
- The handset is not designed to be water resistant. Do not subject to direct, high water pressure or submerge under water for a long period.
- Do not wash in a washing machine, sonic washer, etc.
- Do not immerse in a bathtub. The handset is not designed to be heat resistant.
- Condensation from rapid changes in temperature may cause malfunction. Before bringing the handset into a bath room or other warm place from a cold place, let it adjust to room temperature.
- The handset does not float on water.

Back cover

- Be sure the back cover is complete attached. Anything tiny (a single hair, etc.) caught in the sealing surfaces may allow ingress of water.
- Do not wear gloves when removing or reattaching the back cover. Anything tiny (a single hair, etc.) caught in the sealing surfaces may allow ingress of water. When closing the cover, wipe away any moisture or dirt with a dry, clean cloth, even if it only appears very small.
- A deteriorating or damaged back cover will not allow the handset to be water resistant.

Attaching the back cover

- 1 With the handset closed, align the back cover with the handset and attach

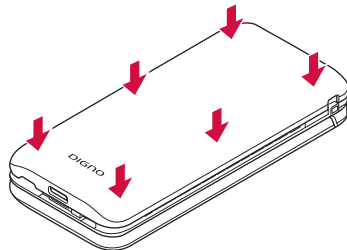

- 2** Slide your fingers around the back cover in direction of ①, and press firmly in direction ② to attach it completely

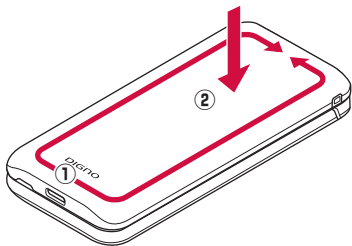

Removing the back cover

- 1** With your fingertip (fingernail) in the notch in the back cover, lift shown and remove

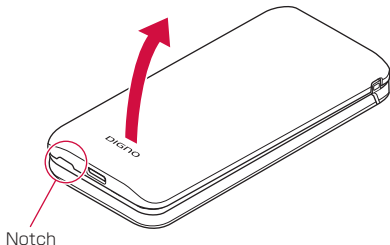

If liquid other than water is on handset

- If anything other than water (seawater, detergent, alcohol beverages, etc.) is on the handset, immediately rinse with water.
- Wiping may be done using a soft cloth dampened with foam hand soap, isopropyl alcohol, ethanol, or sodium hypochlorite (→P. 26).
- The handset can be washed with low-pressure water flow (6 L/min or less tap water at room temperature (5° C and 35° C)), holding it approximately 10 cm below the faucet or shower head.
- If soiled, hold the handset making sure the back cover cannot open, and hand-wash without using a brush.

After becoming wet with water

- After the handset has become wet with water, do not remove the back cover, and wipe away water on both the handset and the back cover with a dry, clean cloth.
- In cold regions, any moisture on the handset may freeze. Using the handset with frozen moisture may cause malfunction. Do not leave wet.

Rubber gasket

- The rubber gasket on the handset when the back cover is removed is important to handset water resistance. Do not scratch or remove.
- Be careful not to pinch the rubber gasket when closing the back cover. Forcing the back cover on with the rubber gasket pinched will scratch the gasket and may affect water resistance. Anything tiny (a single hair, etc.) caught in the sealing surfaces may allow ingress of water.

- Any liquid other than water on the gasket may affect gasket durability.
- Do not insert anything pointed in the back cover gaps. May damage or deform the handset, and may scratch the gasket and allow ingress of water.
- The rubber gasket at the back cover and handset sealing surfaces is important to handset water and dust resistance. Do not remove or scratch it. Do not allow dirt to get on the gasket. If the rubber gasket is scratched or deformed, contact a docomo-designated repair counter.

Heat resistance

- Do not immerse or splash with hot water. Do not expose to hot air as in a sauna or from a dryer. The handset is not designed to be heat resistant.

Impact

- While the handset is shock resistant, shock resistance assumes usual everyday use. The handset may break if subjected to excessive shock such as being thrown or dropped forcibly.

NOTE

- To maintain water and dust resistance, it is recommended to replace parts every 2 years regardless of their condition. The handset can be submitted to a DOCOMO-specified repair office for parts replacement at a fee. For inquiries, see the back cover of this manual.

Caring for the handset

Soiling on the handset can be wiped away with foam handsoap, alcohol, etc.

- Before caring for the handset, power off the handset and remove all wire connections.

If using foam handsoap/foam body soap

- 1 Squeeze a little foam handsoap/foam body soap onto a soft cloth and wipe briskly
 - Be careful that no foam enters the holes in the earpiece/speaker, mouthpiece/microphone, air pressure hole, or external connector terminal.
- 2 Rinse away all foam completely
 - Rinse the holes in the earpiece/speaker, mouthpiece/microphone, air pressure hole, or external connector terminal for about 30 seconds.
- 3 Drain the holes in the earpiece/speaker, mouthpiece/microphone, air pressure hole, and external connector terminal adequately (→P. 28)
- 4 Dry adequately, and check that no moisture is remaining (→P. 28)

If using alcohol

1 Dab a lint-free, soft cloth with a small amount of isopropyl alcohol, ethanol, or sodium hypochlorite (such that the cloth is dampened), and wipe the handset.

- * No noticeable discoloration or fading was confirmed in testing assuming wiping with disinfectant alcohol sheets. However, handset resistance is verified under test conditions, and complete non-occurrence of discoloration or fading is not guaranteed.
- * Always carefully read instructions for using any of isopropyl alcohol, ethanol, or sodium hypochlorite sold as a disinfectant. Improper use can pose risks to health and as a flammable substance.
- * Immersing the handset or directly spraying isopropyl alcohol, ethanol, or sodium hypochlorite may cause malfunction. Always use a soft, dampened cloth.

NOTE

- Be sure to remove any store-bought accessories (straps, etc.). Check precautions given for store-bought accessories.
- The handset is not designed to be water resistant. Do not subject to direct, high water pressure or submerge under water for a long period.

- When caring for the handset, check that the back cover is attached firmly.
 - * Use domestic-brand foam-type handsoap/body soap. Do not mix different types of foam handsoap/foam body soap.
Do not use: kitchen, business, non-additive, or alkaline handsoap, business, non-additive, or alkaline body soap, soap, detergent, bath salts, shampoo, rinse, facial cleanser, makeup remover, toothpaste, etc.
If on the handset, immediately rinse with water.

When charging

- Accessories and optional parts are not waterproof/dustproof. Check the following when and after charging.
- Never charge the handset while it is wet. May cause fire, burns, injury, electric shock, etc.
- Check that the handset is not wet. Before charging wet handset, first drain well, then wipe away moisture with a dry, clean cloth, and let dry at room temperature for at least an hour before placing in a desktop holder (KY01) (sold separately).
- Do not touch a specified AC adapter (sold separately) or desktop holder (KY01) (sold separately) with your hands wet. May cause electric shock.

- Use a specified AC adapter (sold separately) or desktop holder (KY01) (sold separately) where not exposed to water, and do not use them near water sources (bath room, shower, sink, basin, etc.). May cause fire, burns, electric shock, malfunction, etc. Even when not charging, do not bring in a bath room, etc. May cause fire, burns, electric shock, malfunction, etc.
- Check that no moisture or dirt remains in the external connector terminal before use.

Draining water when the handset gets wet

If the handset is wet with water, always drain the holes in the earpiece/speaker, mouthpiece/microphone, hinge, air pressure hole, and external connector terminal. Continuing to use the handset wet cause wetting inside clothing or a bag or cause sound to be inaudible.

- ① Wipe off water on the handset with a lint-free, dry, clean cloth

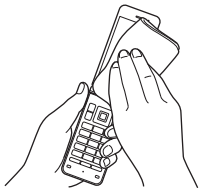

② Shake the handset

- ① Hold the handset firmly and shake as shown until no more water drains out
 - Before shaking the handset, check around you for hazards.
 - Hold the handset firmly so it does not fly out of your hand when draining water.

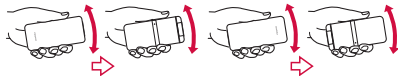

- ② Wipe off any water draining from the handset
 - Water is particularly difficult to drain from the earpiece/speaker, mouthpiece/microphone, air pressure hole, and external connector terminal. Hold each downward and pat on cloth to wipe.
- ③ Place on a dry towel or cloth, and leave for a while to dry at room temperature

- 3** Pat the handset gently on a lint-free, dry, clean cloth and wipe away the moisture in the gaps in the earpiece/speaker, mouthpiece/microphone, hinge, air pressure hole, external connector terminal, etc.

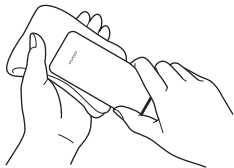

- 4** After adequately removing moisture from the handset, leave it to dry for at least an hour at room temperature







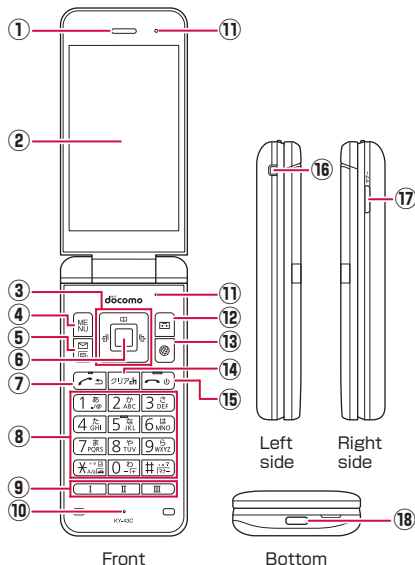

- Moisture may be remaining in the handset. Do not place the handset near items you do not want to become wet. Use care, as it can cause wetting inside clothing or a bag.

Before Using the Handset

Part names and functions



- ① **Earpiece/speaker**
 - Hear the other party's voice during a call, ringtone, music, alarm, etc.
- ② **Display**
- ③ **Cursor keys**
 - Move the cursor to select an item.
 - May be described as , , , in operation steps.
 - Press the following keys in the standby screen to activate the following functions.
 - : Displays call history list
 - : Displays redial list
 - : Displays the phonebook
 - : Use the focus mode
- ④ **Menu key**
 - Display the menu, or use the menu function in the operation guidance.
- ⑤ **Mail key**
 - Activate the mail app, or use the menu function in the operation guidance.
 - Press for at least 1 second in the standby screen to check new mail.
- ⑥ **Center key**
 - Select/set an item.
 - Press in the standby screen to activate focus mode.
- ⑦ **Call key**
 - Use to make/receive calls.
 - Press in the standby screen to display the dial screen.
- ⑧ **Dial keys**
 - Enter phone numbers or characters.

- In the standby screen, press the  key for at least 1 second to enter/exit Drive mode.
 - Press the  key for at least 1 second in the standby screen to enter a "+".
 - In the standby screen, press the  key for at least 1 second to set/cancel Manner mode (→P.103).
- ⑨ : **Custom keys**
- Custom keys →P. 59
- ⑩ **Mouthpiece/microphone**
- Talk to the other party during a call, or use when recording a call.
- ⑪ **Air pressure hole**
- The handset has a water- and dust-resistant design, and so is tightly sealed. The vent allows air out.
 - The air pressure hole does not affect water or dust resistance.
 - Do not cover the vent with a protective sheet or sticker.
- ⑫ : **Voice/answering memo key**
- Activate the voice/answering memo menu, or use the menu function in the operation guidance.
- ⑬ : **Browser key**
- Display the web menu, or use the menu function in the operation guidance.
- ⑭ : **Clear key**
- Delete entered characters or numbers, or return to the previous screen.
 - Press in the standby screen to display the channel list of i-channel.
- ⑮ : **Power/end key**
- Press for at least 2 seconds to power on the handset (→P.52).
 - Press for at least 1 second to power off the handset (→P.52).
 - End active function and display the standby screen.
- ⑯ **Straphole**
- To attach a strap, remove the back cover (→P.25), insert the strap through the straphole and around the strap pin inside the handset (→P.40), and then replace the back cover (→P.24).
- ⑰ : **Manner key**
- Press in the standby screen to display settings menu of Manner mode.
 - In the standby screen or with the handset closed, press for at least 1 second to set/cancel Manner mode.
 - Press with the handset closed to turn on the sub-display or switch the display.
- ⑱ **External connector terminal**
- Use to charge or to connect an earphone/microphone, PC, etc.
 - * If using a USB Type-C earphone/earphone conversion cable to connect an earphone/microphone, only analog is available.

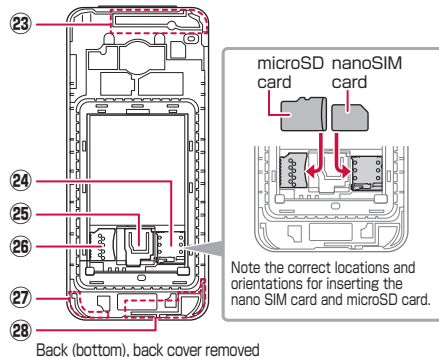
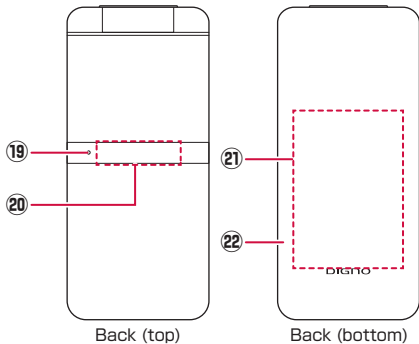

19 Incoming/charging lamp

- Lights/flashes when a call is arriving or while charging.

20 Sub-display

21 Battery pack

22 Back cover

23 Internal main antenna area*1

24 nano SIM card slot*2

25 Stopper

26 microSD card slot*2

27 Internal GPS / Wi-Fi / Bluetooth antenna area*1

28 Internal sub antenna area*1

*1 Antenna is built into handset. Covering antenna areas with hand may affect quality.







*2 Note the correct locations and orientations for inserting the nano SIM card and microSD card. Installing/removing →P. 41, P. 46

Basic operation

The following describe basic handset operations such as selecting items, or viewing screen display or icons.

Using the cursor keys (selecting items)

- After moving the cursor, the color of the cursor position changes or a frame appears around an item.
- Operation descriptions and operation on the handset is as follows.





Description	On handset
In the standby screen,  ► [Settings] ► [Wallpaper/Display]	In the standby screen, press  ► Point the cursor to [Settings] using  and then press  ► Point the cursor to [Wallpaper/Display] using  and then press 

- For operations ending with  pressed after an item is selected/entered, the description of pressing  is omitted in this manual.

NOTE

- Explanations in this manual are based on the handset at time of purchase. Actual menus and items may differ depending on any settings you made.

Selecting with the dial keys (shortcut operation)

This allows you to select menu items by pressing a corresponding dial key ( - ) and ,  when menu items have numbers (shortcut numbers) assigned.





- Press the item number for the menu item. If a menu does not have item numbers, select with the cursor keys.

Executing items at the screen bottom

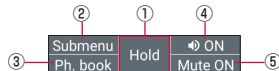

Press the function keys (, , , ) or center key () to use the menu and functions at the screen bottom.

- Displayed items vary by screen.







- ① "Hold": Press .
- ② "Submenu": Press .
- ③ "Phonebook": Press .
- ④ "Speaker on": Press .
- ⑤ "Mute on": Press .





NOTE

- If the items do not appear at the screen bottom, such as when viewing an image, press , , , etc. for items.

Using the pointer

Use  /  /  /  to move the pointer on the handset. Activate a pointer-compatible function/app and activate the pointer to use the onscreen pointer.

1 Activate a pointer-compatible function/app

"" (off)/"" (on) appears in the status bar, and "" (pointer) appears when the pointer is activated. "" appears when the pointer is above a selectable button, item, etc.





When using the pointer

When using a browser, you can move the onscreen pointer up/down, left/right to navigate.









■ Activating the pointer

1 When a pointer-compatible function/app is running, long-press for at least 1 second

The pointer switches on/off.

- While the pointer is activated, key operations (other than  /  /  /  / ) are available (except some apps).

■ Moving the pointer





Press  /  /  /  to move the pointer up/down, left/right. Also, you can press  or  together with  or  to move diagonally.









■ Selecting buttons, etc.

Press  when the pointer is above a button, item, etc. you want to select to set (execute) it.

■ Scrolling the screen

When the pointer is at the top, bottom, left, or right screen edge, press  /  /  /  to move outward from the screen.

- Press  for at least 2 seconds to change the pointer to "" and then press  /  /  /  to scroll the screen.

Standby screen layout

In the standby screen, you can check the current status and new arrival information.



① Status bar

- Check current handset status with notification icons and status icons.

② Notification icons

- Notifications for auto answering memos, missed calls, voicemail, etc.

③ Time/date

④ i-channel telop

- If you subscribe to i-channel, i-channel information flows here automatically.







Using focus mode

Selecting the time/date or notification icons in the standby screen allows you to activate corresponding apps, view information, etc.

① In the standby screen,

- Focus mode activates.





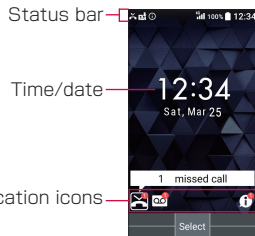

② Select the status bar / time/date / a notification icon

- To deactivate focus mode:  / 
- While in focus mode, pressing  /  /  /  does not display menus or activate functions.



Checking notification details from notification counters

Notification counters appear in the standby screen when a call is missed, new mail is received, etc.

- Main notification counters and operation when selected are as follows.
 -  (Answering memo): Display the Answering memo list.
 -  (Missed call): Display the incoming call list.
 -  (Recorded messages of voicemail): Display confirmation for dialing to voicemail center.
 -  (New mail): Display the Inbox.
 -  (New +Message): Display the list of +Message thread.
 -  (Notification information): Display the status panel.
- Notification counters other than those with notification information will disappear when you check the content. An icon for voicemail service will disappear when you delete the recorded message.





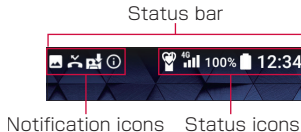



















Status bar

Check different statuses from the status bar at the top of the screen, with notification icons and status icons.



■ Main notification icons

	New +Message/SMS	P.78
---	------------------	------

	New mail	P.75
	New PC mail	P.82
	New Area Mail	P.128
	Error indication ● Displayed when an error has occurred.	—
	Data disabled ● Displayed when a data limit has been reached.	P.108
	Alarm sounding/snoozing	P.91
	Schedule event notification	P.90
	Call arriving / talking / dialing	P.60
	Missed calls	P.64
	Answering memo	P.67
	microSD card mounted	P.116
	Available handset memory low	P.116
	Request to receive Bluetooth data	P.127
	Send indication	—
	Receive indication	—
	Save screenshot	P.39
	[USB tethering] enabled	P.112
	[Bluetooth tethering] enabled	
	Multiple tethering enabled	
	Software update available	P.150
	Omakase Lock is set	—
	+Message enabled	P.78
	i-channel information available	—
	Unshown notification icons	—

■ Main status icons

	Battery level 100% / no charge / charging	—
	Battery Care mode [ON]	P.114
	Signal level	—
	Out of service area	—
	Data communication	—
	Airplane mode	P.108
	3G available	—
	4G (LTE) available	—
	During international roaming	P.136
	Manner mode	P.103
	Drive mode	
	Silent mode	
	Pointer enabled	P.34
	Pointer disabled	P.34
	Calling handsfree	P.65
	Muted	P.65
	Alarm set	P.91
	Bluetooth connected	P.125
	Wi-Fi connected	P.108
	Wi-Fi connected, no Internet access	—
	[Wi-Fi hotspot] enabled	P.112
	VPN connection	P.113
	Answering memo set	P.67
	All answering memos used	

Notifications list

View notification details and activate corresponding apps.

① (at least 1 second)

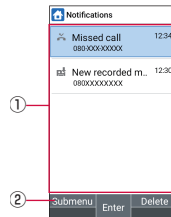

① Notification area

- View handset status and notification details. Select a notification to activate the corresponding function and view the details.

② Submenu

- Delete and set notifications.

Changing settings

When a checkbox, etc. appears for an item, you can enable/disable the setting or switch [ON]/[OFF] by pointing the cursor to the item and then pressing **[]**.

- **[]** is enabled, **[]** is disabled.
- When [CheckAll]/[UnchkAll] appears in the operation guidance, press a corresponding function key to select/deselect all items.

Example: Sound/Notification screen, alarm screen

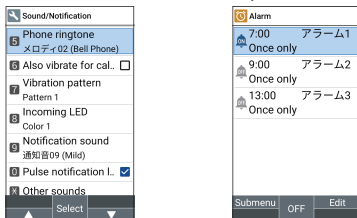

NOTE

- Number of items or details of a notification counter appear for some items.

Incoming/charging lamp

- Incoming/charging lamp lights or flashes when a call is arriving, charging, etc.
 - Lit red: charging
 - Flashing blue: call arriving / missed calls / answering memos / new mail/+Message/SMS

NOTE

- The color of the incoming/charging lamp can be changed (→P.102).

Sub-display

The sub-display displays a date and time, device status such as the manner mode and battery level, and caller name, etc.

- The sub-display lights when you press **[マナ-]** while the product is closed or after you close the product.

Viewing the Sub-display

Display switches by pressing **[マナ-]**.





















Clock





Status icons

■ Main icons

	Signal level
	Out of service area

	Airplane mode
	3G available
	4G (LTE) available
	Battery level  100% /  no charge /  charging /  Battery Care mode [ON]
	Manner mode status  Manner mode /  Drive mode /  Silent mode
	Missed calls
	Answering memo
	New mail
	New +Message/SMS
	Wi-Fi® connection status  Wi-Fi® connected /  Wi-Fi® connected (Open)

Capturing screenshots

Press  and  together for at least 1 second to capture an image of the current screen.

- The captured image is saved to the handset memory and can be viewed in "Pictures" in the Data folder.



NOTE

- All or a part of image may not be saved depending on the app.

Profile

Display your own phone number registered to the nano SIM card. You can register a name, mail address, etc.



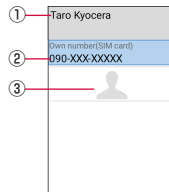

- By default, only the phone number which is registered to the installed nano SIM card is displayed.

- 1 In the standby screen,   [Profile]
- 2 Check/use the profile



- 1 First, last names / reading
 - Displayed when a name is registered.
- 2 Own phone number
- 3 Image

■ Editing/using a profile

- 1 In the standby screen,  ► [Profile]
- 2  ► [Edit Profile] ► Set each item ► 
 - Items that can be set →P. 71
 - Send the profile:  ► [Send data (share)] ► Follow the instructions on the screen
 - Copy an item: Point the cursor to an item to copy ► 

■ Checking the mail address

- 1 In the standby screen, 
- 2 [Mail settings] ► [My address]
 - Select [Update] to update My address information.

Attaching a strap

Remove the back cover before attaching a strap (→P.25). Reattach the back cover after attaching a strap (→P.24).

- 1 Insert the strap in the straphole
- 2 Hook the strap securely on the strap pin, and then pull strap outward

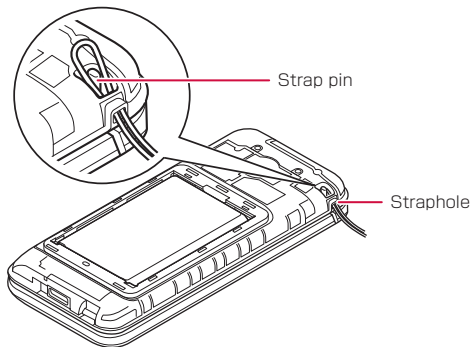

3 Reattach the back cover

NOTE

- Check that the strap is hooked securely on the strap pin. A strap caught between the handset and the back cover will prevent the back cover from being closed completely, and will affect water and dust resistance. The strap will also become unhooked and may cause breakage or injury.

nano SIM card

The nano SIM card is an IC card that contains personal information, such as your phone number.

- The handset accepts only a nano SIM card. If you have a mini SIM card, SIM card, or FOMA card, bring it to a docomo Shop to replace it with a nano SIM card.
- You cannot use functions such as the phone or packet communication without inserting a nano SIM card.
- In Japan, you cannot call emergency numbers (110, 119, or 118) without inserting a nano SIM card.
- For details on a nano SIM card, refer to the NTT DOCOMO website.

Installing/removing a nano SIM card

- Before installing or removing a nano SIM card, power off the handset, turn the handset back-side up, and remove the back cover (→P.25) and the battery pack (→P.48). Hold the handset firmly with handset closed. After installing or removing a card, reattach the back cover (→P.24) and the battery pack (→P.47).

Installing a nano SIM card

- 1 Lift the tab as shown

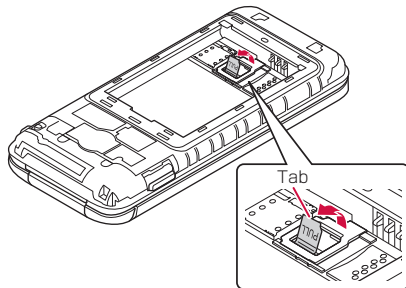

2 Pull the tab and lift the stopper as shown

- Be careful not to lift the stopper forcefully. May damage the stopper.

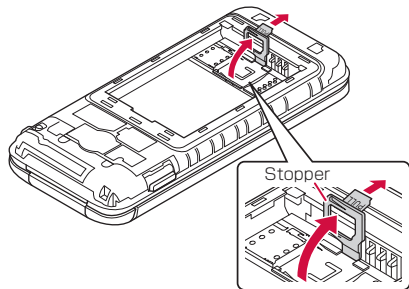

3 With the IC (metal) portion of the nano SIM card downward, slide as shown in the nano SIM card slot and push until it clicks

- Note the location of the notch.

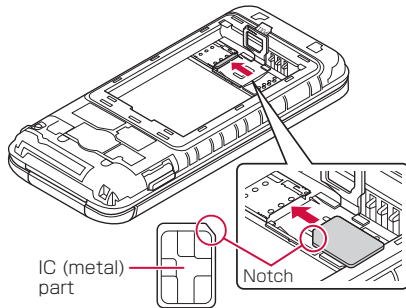

4 Lower the stopper until it clicks locked

- If the stopper does not close, lift the stopper again and check that the nano SIM card is inserted all the way correctly.

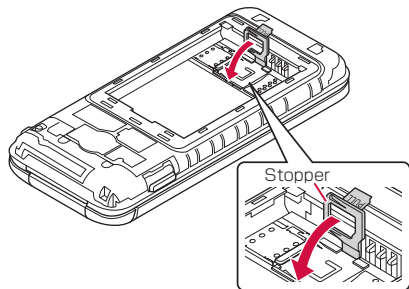

NOTE

- Lock the stopper securely.
If not locked, the nano SIM card can come out of place if the handset is bumped.

Removing a nano SIM card

1 Lift the tab as shown

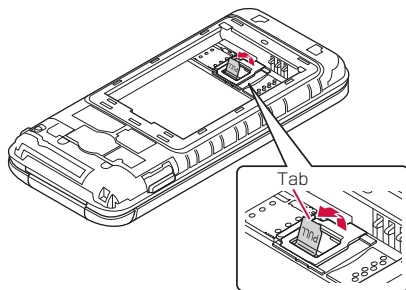

2 Pull the tab and lift the stopper as shown

- Be careful not to lift the stopper forcefully. May damage the stopper.

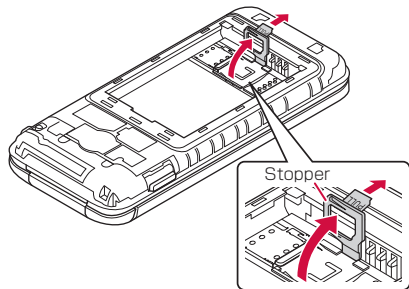

3 Press the nano SIM card in until it clicks (①), and then pull it straight out (②)

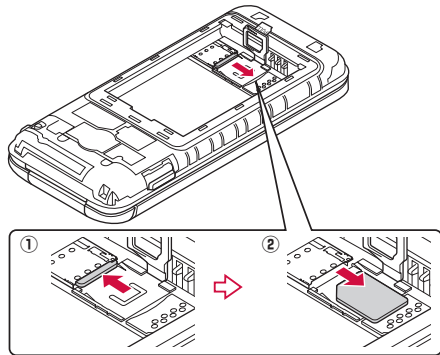

4 Lower the stopper until it clicks locked

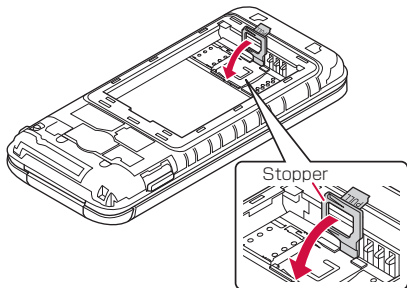

NOTE

- Be careful not to drop the nano SIM card when removing it.
- Make sure not to touch or scratch the IC (metal) on the nano SIM card when handling it. Also, note that inserting or removing the nano SIM card forcibly may damage it or deform the nano SIM card slot.
- Do not misplace the nano SIM card once it is removed.

Security code for nano SIM card

A nano SIM card has a security code called PIN code (→P. 105).

microSD card

You can save data on the handset to a microSD card or import data on a microSD card to the handset.

- Commercially available microSD cards up to 2 GB and microSDHC cards up to 32 GB can be used with KY-43C (as of Feb. 2023).
- Do not power off the handset immediately after inserting the microSD card in the handset (while writing information needed for handset operation) or while editing data on the microSD card. Data may be corrupted or the handset may not work properly.
- Format unformatted microSD cards on the handset before use (→P. 116). microSD cards formatted by PCs or other devices may not be used properly on the handset.
- Data saved on microSD cards from other devices may not be displayed or played on the handset. Some data saved on the microSD card from the handset may not be displayed or played on other devices.
- Back up data saved on the microSD card or otherwise store in another place. DOCOMO shall not be liable for any loss or change of saved data.

Installing/removing a microSD card

- Before installing or removing the microSD card, power off the handset, turn the handset back-side up, and remove the back cover (→P. 25) and the battery pack (→P. 48). Hold the handset firmly with handset closed. After installing or removing a card, reattach the back cover (→P.24) and the battery pack (→P.47).

Installing the microSD Card

- 1 Lift the tab (→P. 41)
- 2 Pull the tab and lift the stopper (→P. 42)
 - Be careful not to lift the stopper forcefully. May damage the stopper.

- 3 With the terminals (metal) of the microSD card downward, slide as shown in the microSD card slot
 - Note the orientation of inserting the microSD card.

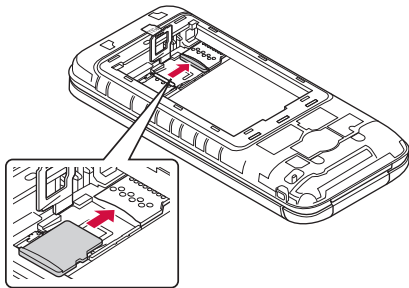

- 4 Lower the stopper until it clicks locked (→P. 43)
 - If the stopper does not close, lift the stopper again and check that the microSD card is inserted all the way correctly.

Removing the microSD card

- 1 Lift the tab (→P. 41)
- 2 Pull the tab and lift the stopper (→P. 42)
 - Be careful not to lift the stopper forcefully. May damage the stopper.
- 3 Slide the microSD card as shown and remove from the microSD card slot

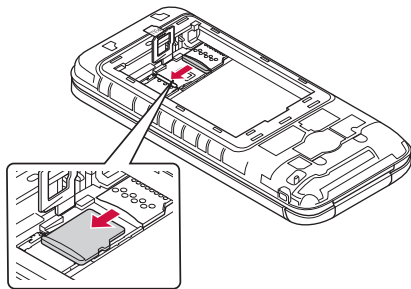

- 4 Lower the stopper until it clicks locked (→P. 43)

Battery pack

Use the battery pack KY01 designed for the handset.

- The battery pack is not waterproof.

Installing/removing the battery pack

- Before installing or removing the battery pack, power off the handset, turn the handset back-side up, and remove the back cover (→P. 25). Hold the handset firmly with handset closed. After installing or removing a battery pack, reattach the back cover (→P.24).

Installing the battery pack

1 Install the battery pack

- Note where the battery pack connects, and slide into place securely.

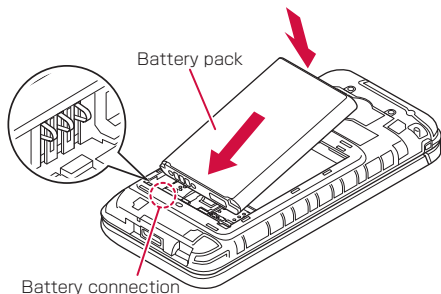

NOTE

- Check that the nano SIM card and any microSD card are securely installed before installing the battery pack.

Removing the battery pack

1 Remove the battery pack

- With your fingertip (fingernail) on the battery pack at the notch in the handset, lift shown and remove.

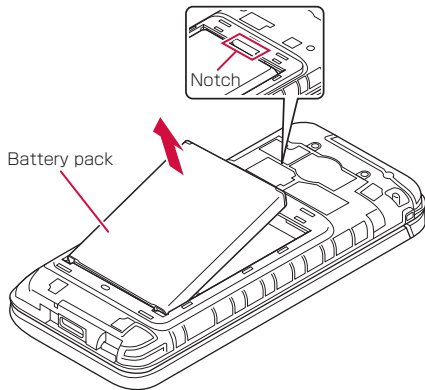

Charging

The battery pack is not fully charged at the time of purchase.

- Approximate charging time →P. 152

Usable time after fully charging (approximate)

The time that the handset can be used depends on the usage environment and condition of the battery pack.

- Approximate usable time →P. 152

Battery pack usable life

- The battery pack is consumable. Available time shortens with each repeated charge.
- Once available time is only about half of when it was purchased, it is approaching the end of its life. It is recommended to replace it soon. Depending on usage, the battery pack may bulge as it approaches the end of its life, but this is not a concern.



Charging

- Approximate charging time and usable time after fully charging →P. 152
- The battery can also be charged with the handset powered on (while charging, [⚡] appears on the battery icon).

- Do not charge for a long time with the handset left powered on. Leaving the handset powered on after charging is complete decreases the battery pack charge level. In this instance, an AC adapter (sold separately) or DC adapter (sold separately) charges the battery pack again. However, depending on when the handset is disconnected from the AC or DC adapter, the battery charge level may be low or the battery pack may only be usable for a short time.
- Leaving the handset unused for a long time even after charging is completed may decrease the battery level.
- If the battery pack has no charge when starting charging, the charging lamp may not light immediately. However, charging is in progress.
- If the handset displays no charge and cannot be powered on, charge the battery pack for a while.
- While charging, you may not be able to power on the handset even when the charging lamp is lit red. Charge longer and try powering on the handset again.
- Frequently recharging the battery pack when it still has charge may shorten its usable life. It is recommended to use up the battery to a certain level (e.g. after the battery level decreases) before charging.
- If the battery pack becomes warm, charging may stop even if the battery pack has not been fully charged. Charging resumes after the temperature lowers to an appropriate temperature.
- Check the NTT DOCOMO Online Shop for the latest adapter compatible with the handset.
<https://onlineshop.smt.docomo.ne.jp/options/search.html> (in Japanese only)

AC adapter and DC adapter

- Refer to the AC Adapter O8 (sold separately) or DC Adapter (sold separately) user guide.
- AC Adapter O8 accommodates from 100 to 240V AC.
- The shape of the plug for the AC adapter is for 100 V AC (for domestic use). To use an AC adapter of 100 to 240 V AC overseas, a conversion plug adapter compatible with your country of stay is required. Do not use a voltage converter for overseas travel to charge the battery pack.

Charging with an AC adapter

- Charging with AC Adapter O8 (sold separately) is described as an example.

① Raise the power plug on the AC adapter and plug into an outlet

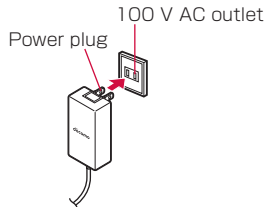

2 Insert the USB Type-C connector on the AC adapter straight into the external connector terminal

- The USB Type-C connector can be inserted either upward or downward.
- Check that the charging lamp on the handset is lit red.
- If the charging lamp flashes in blue (→P.38), flashing in blue has priority.
- When charging is complete, the charging lamp goes out.

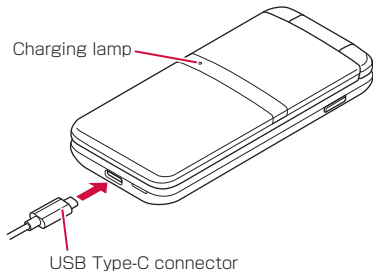

3 After charging is complete, unplug the AC adapter from the outlet

4 Remove the USB Type-C connector on the AC adapter from the external connector terminal

Charging with a desktop holder

- Charging with Desktop Holder KY01 (sold separately) and AC Adapter O8 (sold separately) is described as an example.

1 Insert the USB Type-C connector on the AC Adapter in the connection terminal on the desktop holder

- The USB Type-C connector can be inserted either upward or downward.

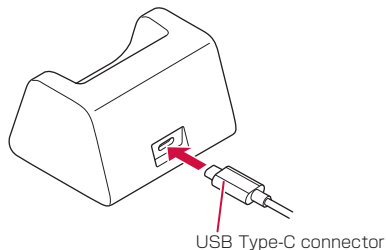

- 2** Raise the power plug on the AC adapter and plug into an outlet

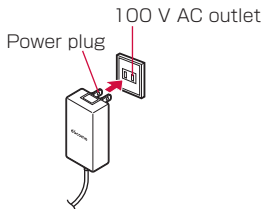

- 3** Place the handset in the desktop holder with the handset closed

- Insert the handset as shown. Note the orientations of the handset and the desktop holder, and ensure that the desktop holder inserts all the way straight and firmly in the external connector terminal.
- Check that the charging lamp on the handset is lit red.
- If the charging lamp flashes in blue (→P.38), flashing in blue has priority.
- When charging is complete, the charging lamp goes out.

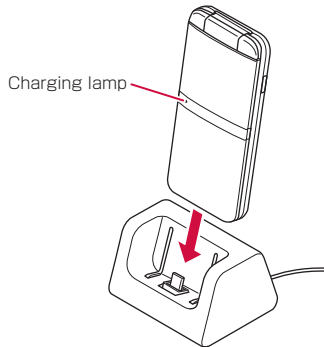

- 4** After charging is complete, remove the handset from the desktop holder
- 5** Unplug the AC adapter from the outlet

Charging with a DC adapter

DC Adapter (sold separately) supplies power when charging from a vehicle accessory socket (12 V/24 V).

- For details on usage, see the DC Adapter user guide.

Charging with a PC

You can charge the handset by connecting the handset to a PC with a USB Cable A to C 02 (sold separately).

- Connecting to a PC →P. 123

Powering on/off

Powering on

- 1  (at least 2 second)

- When you power on the handset for the first time, make initial settings (→P. 57).

Powering off

- 1  (at least 1 second)

- 2 [Yes]

Device Control application

Control function such as phone and Wi-Fi individually, and make settings suitable for work simply using Device Control. Settings can be made from the handset, and does not require a PC. Copies of settings can be made easily.

- To use Device Control, enable Device Control when making initial settings on the handset (→P. 57).
- Using Device Control →P. 98

Text entry

Enter characters for functions or apps requiring text entry such as phonebook and mail on the handset.

A text entry screen

Multiple characters are assigned to each dial key. Character switches by pressing a key.

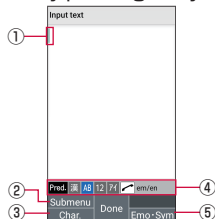

① Cursor

- Point the cursor to a position to add text.

② Submenu

- You can copy/paste text, make text entry settings, etc. (→P. 56).

③ Char.

- Change the type of characters entered.
 - Press  to switch the character type in the order of en-width alphabet → en-width numeric → en-width katakana → hiragana/kanji.

④ Input mode

- Check the input mode. The current character type is shown with a blue icon.

⑤ Emoji, emoticons, symbols

- Show emoji, emoticon, and symbol lists.
 - They may not be enterable depending on the app.

Kana entry and 2-touch entry

After switching the character type to that other than en-width numeric, use either of two entry methods: "kana method" and "2-touch method" (→P. 56).

Converting characters

Enter hiragana and press  for a list of conversion candidates of katakana, alphabet, numbers, symbols, as well as predicted date and time, corresponding to the dial key you pressed while entering text. This is useful for entering alphanumeric, katakana, month and day, time, etc. with the character type as "漢".

Example: Enter "かきく" and press , and conversion candidates such as "ABC" are displayed.

Correcting text

Back function

At times such as when pressing a key too many times and going past a character you want to enter, you can press  to go back to the previous character.

Example: When wanting to enter "き" but have gone to "<", press  to go back to "き".

NOTE

- This function is available when "Input method" is any setting other than "2-touch method".

Undo function

Press  (undo) to cancel the preceding action that you finalized.

Prediction conversion

Set "Conv mode" (→P. 56) to "Predictive conv" to have frequently used words as well as phrases that you have converted/finalized displayed as conversion candidates.

Example: Simply enter "か", and prediction conversion candidates such as "彼" are displayed, and press  to select. Prediction conversion candidates that are predicted to continue after finalized text are also displayed.

Example: Enter "私" and "は", "の", "か", etc. are displayed as prediction conversion candidates. Press  to select.

- You can press and switch between prediction conversion candidates and normal conversion candidates. When "Conv mode" is set to "Normal conv", press to display normal conversion candidates.
- Press before finalizing to cancel conversion.

2-touch entry

Set "Input method" (→P. 56) to "2-touch method" to enter characters using 2-digit numbers. Enter the first digit and a number appears, then enter the second digit to display the character.

Key assignments for 2-touch entry

■ For "漢", "ア", "A" (full)

* With "ア" and "A", full katakana are entered instead of hiragana.

Key pressed for 2nd digit

Key	1	2	3	4	5	6	7	8	9	0
1	あ	い	う	え	お	a	b	c	d	e
	ァ	ィ	ゥ	ェ	ォ	A	B	C	D	E
2	か	き	く	け	こ	f	g	h	i	j
						F	G	H	I	J
3	さ	し	す	せ	そ	k	l	m	n	o
						K	L	M	N	O
4	た	ち	つ ^{*1}	て	と	p	q	r	s	t
			っ			P	Q	R	S	T
5	な	に	ぬ	ね	の	u	v	w	x	y
						U	V	W	X	Y
6	は ^{*2}	ひ ^{*2}	ふ ^{*2}	へ ^{*2}	ほ ^{*2}	z	?	!	-	/
						Z				
7	ま	み	む	め	も	¥	&			
8	や	(ゆ)	よ	*	#	Line break		
	ゃ		ゅ		ょ					(Space)
9	ら	り	る	れ	ろ	1	2	3	4	5
0	わ	を	ん	"	°	6	7	8	9	0
	わ			,	。					

Press to add daku-ten and switch between top and bottom rows. (with usable with characters)

*1 Press once to switch to bottom row character, and press twice to add a "" (daku-ten).

*2 Press once to add a "" (daku-ten), and press twice to add a "" (handaku-ten).

■ For "㍻", "AB" (en)

Key pressed for 2nd digit

Key pressed for 1st digit

Key	1	2	3	4	5	6	7	8	9	0
1	ア	イ	ウ	エ	オ	a	b	c	d	e
	ア	イ	ウ	エ	オ	A	B	C	D	E
2	カ	キ	ク	ケ	コ	f	g	h	i	j
						F	G	H	I	J
3	サ	シ	ス	セ	ソ	k	l	m	n	o
						K	L	M	N	O
4	タ	チ	ツ ^{*1}	テ	ト	p	q	r	s	t
			ツ			P	Q	R	S	T
5	ナ	ニ	ヌ	ネ	ノ	u	v	w	x	y
						U	V	W	X	Y
6	ハ ^{*2}	ヒ ^{*2}	フ ^{*2}	ヘ ^{*2}	ホ ^{*2}	z	?	!	-	/
						Z				
7	マ	ミ	ム	メ	モ	¥	&			
								(Space)	(Space)	(Space)
8	パ	(1)	ヨ	*	#	Line break		
	パ		ユ		ヨ				(Space)	(Space)
9	ラ	リ	ル	レ	ロ	1	2	3	4	5
	@	/	-	_	:	.ne.jp	.co.jp	.ac.jp	@docomo.ne.jp	
0	ワ	ヱ	ン	”	°	6	7	8	9	0
	-	.	ン	、	。	www.	.com	.html	http://	https://

Press to add daku-ten and switch between top and bottom rows. (with usable with characters)

- *1 Press once to switch to bottom row character, and press twice to add a "" (daku-ten).
- *2 Press once to add a "" (daku-ten), and press twice to add a "" (handaku-ten).

NOTE

- Characters may not be enterable in some entry screens or for some items.

Entering emoji / emoticons / symbols

- 1 In a character entry screen,
- 2 Press for emoji / emoticon / symbol list
- 3 Select emoji / emoticon / symbol

Submenu operations when entering characters

- Menu items vary by function, app, or condition of use.

1 In a character entry screen, ▶

Quotation	Enter phrases and data quotations (→P. 56).
Select area (Copy etc)	Select text to copy, cut, paste, or save as vocabulary.
Paste	Paste copied/cut text.
Undo	Cancel the preceding action that you finalized.
Input settings	Set character entry (→P. 56).
Cancel	Stop character entry.

* Displayed items vary by condition.

Entering phrases

Enter pre-registered common phrases or phrases that you saved.

1 In a character entry screen, ▶ [Quotation] ▶ [Phrase]

2 Select a phrase

Setting character entry



Make iWnn IME settings.

1 In a character entry screen, ▶ [Input settings]

User dictionary	Check saved vocabulary. Save new words, as well as edit and delete them.
Phrase	Check phrases. Also, edit and initialize phrases.
Input settings	Make entry settings (→P. 56).
Input method	Select from kana and 2-touch methods.
Reset	Initialize the learning dictionary and entry settings (→P. 57).

Entry settings

1 In a character entry screen, ▶ [Input settings] ▶ [Input settings]

Conv mode	Select the conversion method when entering text from prediction conversion and normal conversion.
Use cand. key	Set conversion candidate text to be selectable with either  or  .

Word learning	Set the handset to learn text finalized from a conversion candidates list when entering text other than Japanese.
Wildcard input	Set prediction based on number of characters.
Auto space input	Set a space to be entered after selecting a word from conversion candidates when entering en-width alphabet.
Auto capitalize	Set sentence-initial characters to be converted to upper case when entering en-width alphabet.
Auto cursor move	Set the distance the cursor moves to after entering characters. <ul style="list-style-type: none"> You can still add "" (daku-ten) /"" (handaku-ten) and convert upper/lower case after the cursor moves.

Reset



- In a character entry screen,  ▶ [Input settings] ▶ [Reset]

Reset learning	Delete all history of text you have entered. <ul style="list-style-type: none"> Entry history of emoji, emoticons, and symbols is also deleted.
Reset settings	Initialize entry settings.

Initial settings

An initial settings screen appears the first time the handset is powered on. Follow the instructions on the screen.

- When the "初期設定を行います" (Make initial settings) screen is displayed, 

- To enable Device Control, instead of , enter . Device Control →P. 98

App permissions

Set permissions for apps.

- "一括許可" (Permit all together) is recommended, as then it is no longer necessary to set permissions for each app.
- You can change app permissions (→P. 117) later.

- [一括許可する] (Permit all together) ▶ [はい] (Yes)

- After selecting [後で設定する] (Set later), set permissions for apps individually (when activating apps, etc.)

- In the ソフトウェア更新 (software update) screen, move the cursor to "同意する" (Agree) on the bottom of the screen ▶ 

Setting docomo services

- Alternatively, in the standby screen,  ▶ [Settings] ▶ [docomo service] to set docomo services.

- 1 When the docomo service setting screen is displayed, [設定をはじめる] (Begin settings)

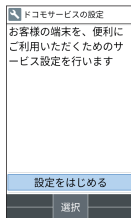

- 2 [同意して設定する] (Agree and set) ▶ Set d ACCOUNT
- 3 [OK]

Changing screen display to English

- 1 In the standby screen,  ▶ [設定] (Settings) ▶ [その他の設定] (More settings) ▶ [言語と入力] (Languages & input) ▶ [言語(Language)] ▶ [English] ▶ [はい] (Yes)

Managing tasks

Using the used apps history

View a history of recently used apps for quick access.

- 1  (at least 1 second)

- You can use this even when using function or app.

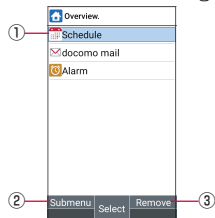

- 1 Used app history
 - Select from the history to activate an app.
- 2 Submenu
 - Exit the displayed app and delete all history.
- 3 Remove
 - You can delete the history of the app the cursor is pointed to.



Using the custom keys

You can save frequently used phone numbers and Favorites functions to a custom key for quick access.

Saving to the custom keys

- 1 In the standby screen,  ► [Settings] ► [Custom key]
- 2 Select the key to save to ► Select the function to save
 - To unsave: Select the key to unsave from ► [OFF]

Using functions saved to the custom keys



- 1  /  / 
 - If you press a key with no function saved, a screen for saving a function is displayed.

Calling

You can use the phone and phonebook, and make settings for voice/answering memo, operation when calls arrive, etc.









Making a call

1 In the standby screen, enter a phone number

- Always enter the city code, even when it is a local number.
- You can set to notify/not to notify the other party of your phone number for each call by adding "186"/"184" to the head of the phone number.
- To delete the last-entered digit: 
- To delete all entered digits:  (for at least 1 second)
- To move the cursor: 



2

- To use a call option and dial:  ► [Call option] ► Set each item ►  / 
- To create/send SMS:  ► [Send SMS] ►  ► Enter a message ► 
- Show speed dials list:  ► [List of speed dials] Speed dials →P. 61
- To register to the phonebook:  ► Select a contact to register ► Set each item ► 

3 To end a call,

- After a call ends and a screen for recording calls appears, select "Yes" to set call recording. Call recording will activate from the next call. Check recorded calls from "Voice memo list" (→P. 67).
- Alternatively, close the handset to end a call.

NOTE

VoLTE



- With VoLTE, you can enjoy high-quality calling.
- To use VoLTE, your handset and other party's handset must meet the following requirements.
 - Use handset compatible with VoLTE
 - Be in an area where VoLTE is available
 - The preferred network mode in mobile network settings must be [4G/3G/GSM(Auto)] →P. 110
- With VoLTE (HD+), you can enjoy higher-quality calling than that of VoLTE. To use VoLTE (HD+), your handset and other party's handset must be compatible with VoLTE (HD+) in addition to meeting requirements for VoLTE.

Entering touch-tone signals

When using services in which you are required to enter numbers additionally during a call, such as a bank balance inquiry or ticket reservation, enter a pause (,)/ wait (;) after entering the phone number to send an additional number added to the main phone number.



Adding a 2-second pause (,)

Once the call connects, the added number will be sent automatically after about 2 seconds.

- 1 In the standby screen, enter the phone number ▶  (for at least 1 second)
- 2 Enter the number to send ▶ 

Adding a wait (;)

After dialing in the main phone number, the handset automatically waits and then confirmation appears for sending an additional number.

- 1 In the standby screen, enter the phone number ▶  (for at least 1 second)
- 2 Enter the number to send ▶ 
- 3 [Yes] during the call

Making a call with speed dials

You can make a call quickly to another party who is registered to a speed dial.

- Save a contact in advance (→P. 71).

Saving to speed dials

- 1 In the standby screen,  ▶ [Phone] ▶ [Speed dial settings]
- 2 Select [<Not Registered>] of any number to save ▶ Select a contact ▶ [OK]
 - If multiple phone numbers are registered in a contact, select the number to save.

Dialing with speed dials

- 1 In the standby screen, enter a speed dial number (0 - 99) ▶ 

Emergency calls

Emergency calls	Phone number
Police	110
Fire and ambulance	119
Marine emergency	118

NOTE

- The handset supports "emergency call location notification".
When you make a call to an emergency number such as 110, 119, or 118, the location dialed from (location) is automatically sent to the agency that has received the emergency call (e.g. the police). Depending on your location and the signal reception, the agency that has received the emergency call may not be able to confirm the exact location. If you are not sending your caller ID by calling with "184" added or other means, your location information and phone number are not sent. However, if the agency that has received the emergency call considers your location information and phone number necessary, such as in a life-threatening situation, the agency can retrieve your accurate location by GPS and phone number regardless of your settings. In addition, the area/timing at which that "emergency call location notification" service is introduced depends on the current preparation of each agency that receives emergency calls.

- In Japan, you cannot call to an emergency number (110, 119, or 118) when a nano SIM card is not inserted, while the SIM PIN is locked, or from the PUK (PIN Unblocking Key) entry screen.
- When calling 110, 119, or 118 from your handset, the police or fire department may return your call for verification purposes. State that you are calling from a mobile phone, and give your phone number and exact present location.
Remain stationary to ensure that the call is not disconnected while you are on the line, and keep the handset turned on to receive calls for approximately 10 minutes afterwards.
- Depending on the region, calls to the local police or fire department may not be made.
- When you make a call to an emergency number (110, 119, or 118) while reject call settings are set, settings are set to [OFF].

International call (WORLD CALL)

WORLD CALL is an international calling service available from DOCOMO devices in Japan.

For details of WORLD CALL, refer to the NTT DOCOMO website.

- The caller ID may not be sent or displayed correctly depending on overseas network operators. In this instance, making a call with incoming history is not possible.

- 1 In the standby screen, (at least 1 second) ▶ Enter the country code ▶ Enter the region code (area code) ▶

NOTE

- As for region codes (area codes) that begin with "0", omit the first "0" when entering. Some countries, such as Italy, require a first "0".

Answering a call

- 1 When a call arrives, the ringtone sounds and the incoming lamp flashes

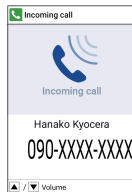

- 2
 - Alternatively, press , - , , or to answer calls.
- 3 To end a call,
 - After a call ends and a screen for recording calls appears, select "Yes" to set call recording. Call recording will activate from the next call. Check recorded calls from "Voice memo list" (→P. 67).

Adjusting ringtone volume

- 1 When a call arrives, the ringtone sounds and the incoming lamp flashes
- 2

Rejecting a call

- 1 When a call arrives, the ringtone sounds and the incoming lamp flashes
- 2  ► [Reject call]



Rejecting a call and sending SMS

- 1 When a call arrives, the ringtone sounds and the incoming lamp flashes
- 2  ► [Reject call with SMS]
- 3 Select a message

Responding with answering memo



- 1 When a call arrives, the ringtone sounds and the incoming lamp flashes
- 2  ► [Auto answering memo]

Playing an answering memo

- 1 In the standby screen,  ► Select the notification counter 
 - Alternatively, in the standby screen,  ► [Answering memo list] to check.
- 2 Select an answering memo

Missed calls

When you cannot answer an incoming call, the notification counter  appears on the standby screen.

- 1 In the standby screen,  ► Select the notification counter 
 - Incoming history list is displayed.
 - Alternatively, in the standby screen, press  to check the incoming history.

Operations during a call

You can use operations such as hands-free calling and adjusting the volume during a call.

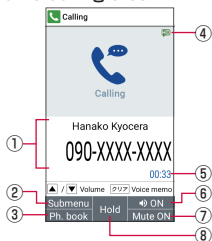

- ① **Other party's name and number**
- ② **Submenu**
 - Change between the incoming history/redial lists/heard effect, and Bluetooth calling.
- ③ **Ph. book**
 - Display the phonebook.
- ④ **High quality indication**
 - Appears during a high-quality VoLTE call.
 - Also appears at times such as when a VoLTE call is arriving.
- ⑤ **Call time**
- ⑥ **Speaker on/off**
 - Switch hands-free calling on or off.
- ⑦ **Mute on/off**
 - Switch muting on or off.

⑧ Hold

- Hold/unhold a call.

NOTE

- Note the following when using hands-free calling.
 - When calling outdoors, in a location where surroundings are noisy, or where the sound echoes loudly, use an earphone/microphone.
 - If the sound cracks during a hands-free call, lower the volume.

Adjusting the in-call volume

① During a call,

Adding a call

Place a current call on hold and make a call to another party.

- Subscription to Call Waiting Service is required to add a call.

Example: Displaying the phonebook to add a call

① During a call,

② Point the cursor to a contact

- If multiple phone numbers are registered in a contact, a screen for selecting call number appears.
- To switch parties, during a call, press .

Displaying the redial/incoming history lists

- 1 During a call, **[ME/NU]** ▶ **[Incoming history]** / **[Redial]**
 - Alternatively, during a call, press **[*]** / **[#]** to display redial/incoming history.

Switching voice output

- You can only switch when a Bluetooth device is connected.

- 1 During a call, **[ME/NU]** ▶ **[Switch to terminal call]** / **[Switch to Bluetooth call]**

Voice memos

- You can only use voice memos when "Record later" is disabled.

- 1 During a call, **[クリア]**
 - Recording starts.
- 2 **[■]**
 - The recorded voice memo is saved.

Redial/incoming history

The handset memory keeps a record of the 50 each of the most recent outgoing and incoming call history calls.

- 1 In the standby screen, **[*]** / **[#]**

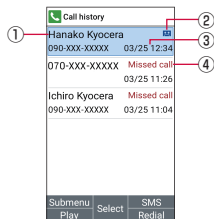

Incoming history list

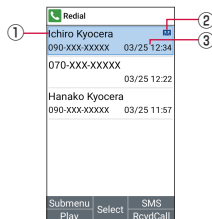

Redial list

- 1 Other party name/number
- 2 Voice memo/answering memo
- 3 Date/time of call in or out
- 4 Missed call

- 2 Point the cursor to a call

- Play a voice/answering memo: **[☑]**
- Switch redial/incoming history lists: **[🔄]**

- 3 **[↶]**

- To create/send SMS: **[☑]** ▶ **[☑]** ▶ Enter a message ▶ **[☑]**
- Create/send mail: **[ME/NU]** ▶ **[Create mail]** ▶ **[docomo mail]** / **[PC Mail]** ▶ Create mail ▶ **[☑]**
- Make a call with set conditions such as caller ID notification: **[ME/NU]** ▶ **[Call option]** ▶ Set each item ▶ **[↶]** / **[ME/NU]**

- Verify location: ► [Verify location] ► [imadoco search]
 - The handset accesses [imadoco search] website. For details on imadoco search, refer to the NTT DOCOMO website.
 - Packet communication charge is incurred for using the service.
- Save to the phonebook: ► [Register] ► Select where to save ► Set each item ►
- Register a number to block: ► [Blocked number] ► [Register to Nuisance call blocking service] / [Register to specified number rejection] ► [OK] / [Block]

Deleting redial/incoming history items

- 1 In the standby screen, /
- 2 Point the cursor to a call ► ► [Delete] ► [Delete one] ► [OK]
 - Delete selected items: ► [Delete] ► [Delete multiple] ► Select a call ► ► [OK]
 - Delete all calls: ► [Delete] ► [Delete all] ► [OK]

Voice memo/answering memo

You can play or set voice memos and answering memos. Set the answering memos and the handset answers calls and records the caller's message when you cannot answer.

- Up to 100 voice memos and 50 answering memos can be recorded. Record up to 60 seconds per answering memo and up to 60 minutes per voice memo.
- However, the maximum savable number of voice memos and recordable time per memo differ with available microSD card space.



- 1 In the standby screen, ► [Phone] ► [Call/Ans Memo]

Answering memo list	Play answering memos as well as delete, protect/unprotect, etc.
Voice memo list	Play voice memos as well as delete, protect/unprotect, copy to microSD card, etc.
Auto answering memo	Make settings for operation of answering memos.
Answer time	Set how long before the answering memo answers a call.
Response message	Set a message for when the answering memo answers a call.
Auto answering in Drive mode	Enable an answering memo response for when driving.
Record later	Enable recording of calls after calls have ended.

NOTE

- If the number of saved answering memos exceeds the maximum number that can be saved, old answering memos which have not been protected are deleted starting from the oldest one. If all answering memos are used and protected, the handset does not respond to calls with an answering memo.
- If the number of saved voice memos exceeds the maximum number that can be saved, old voice memos which have not been protected are deleted starting from the oldest one.
- Alternatively, in the standby screen, press  to display.

Playing voice/answering memos

- 1 In the standby screen,  ► [Phone] ► [Call/ Ans Memo] ► [Answering memo list] / [Voice memo list]
 - Alternatively, in the standby screen,  ► [Answering memo list] / [Voice memo list] to display.
- 2 Select voice/answering memo to play
 - A playback window appears, and the voice/ answering memo plays.
 - To stop playback, press .

Call log/call settings

- 1 In the standby screen,  ► [Phone] ► [Call log/Call settings]

Network service	Network service →P. 68
Roaming settings	Roaming settings →P. 136
Incoming call settings	Incoming call settings→P. 69
Outgoing call settings	Outgoing call settings →P. 70
Other settings	Other settings →P. 70

Network service

- 1 In the standby screen,  ► [Phone] ► [Call log/Call settings] ► [Network service]

Voice mail service	A service to answer calls with a reply message and record callers' messages for you.
Call forwarding service	A service to forward calls.
Call waiting	A service to place the current call on hold and answer a new incoming call.

Caller ID notification	Display your phone number on the other party's phone when you make a call.
Block nuisance call	Register and reject phone numbers of "nuisance calls" such as prank calls.
Caller ID request	Respond to calls that do not display a caller ID with guidance asking that they display their caller ID.
Call notification	Notify you of incoming call information with SMS.
English guidance	Play guidance in English for setting network services, when outside the service area, etc.
Remote operation	Use voicemail service, call forwarding service, etc. from a touch-tone land-line phone, pay phone, DOCOMO mobile phone, etc.
Public mode (power OFF)	When handset is powered off and a call arrives, play guidance that you are where mobiles must be powered of and are unable to answer, and then automatically disconnect the call.

Incoming call settings

1 In the standby screen,  ► [Phone] ► [Call log/Call settings] ► [Incoming call settings]

Voice/Ans memo	Voice/Ans memo →P. 67
Reject call setting	Reject call setting →P. 70
Set ring start time	Set to sound ringtone after specified number of seconds have passed for a call from a party who is not saved in the phonebook.
Edit rejection SMS	Edit a text to send as SMS after rejecting a call.
Step-up ring volume	Set whether ringtone volume gradually increases for subsequent calls from a same number within 10 minutes after a missed call.
Any key answer	Enable calls to be responded to by pressing any dialpad key.
Open and Answer	Enable opening handset to connect a call.
Auto Answer	Set the handset to respond to calls automatically when earphones or a Bluetooth device is connected. Also set response time for arriving calls.
Incoming extension	Enable ringtone/vibration for arriving extension calls. Also set a ringtone for arriving extension calls.

Reject call setting

- 1 In the standby screen, **ME** **NU** ▶ [Phone] ▶ [Call log/Call settings] ▶ [Incoming call settings] ▶ [Reject call setting]

Reject unregistered call	Set to reject calls from callers not saved in the phonebook.
Reject anonymous call	Set to reject calls from callers not sending their phone numbers.
Reject payphone call	Set to reject calls from pay phones.
Reject unknown call	Set to reject calls from callers whose phone numbers cannot be sent.
Specified number rejection	Set to reject calls and SMS from specified numbers. <ul style="list-style-type: none">● Set a specified number: [Add number] ▶ [OK] ▶ Enter the phone number ▶  ▶ [OK]

NOTE

[Specified number rejection]

- You can also specify phone numbers to reject from [Block nuisance call] (→P. 69).

Outgoing call settings

- 1 In the standby screen, **ME** **NU** ▶ [Phone] ▶ [Call log/Call settings] ▶ [Outgoing call settings]

Prefix settings	Set prefix numbers.
-----------------	---------------------

Other settings

- 1 In the standby screen, **ME** **NU** ▶ [Phone] ▶ [Call log/Call settings] ▶ [Other settings]

Snooze of missed call	Enable the handset to notify you again with a missed call after a set time (5, 10, 20, 60 minutes).
Call Time	Check accumulated call time.
Heard effect	Adjust to optimize call voice.
Contact docomo	Contact docomo →P.71
Extension line service setting	Extension line service setting →P.71

Contact docomo

- 1 In the standby screen,  ► [Phone] ► [Call log/Call settings] ► [Other settings] ► [Contact docomo]



ドコモ故障問合せ (Repairs)	Call and inquire about malfunctions.
ドコモ総合案内・受付 (General inquiries)	Call for general inquiries.
海外からのお問合せ (Inquiry from overseas)	Call and inquire about loss, theft, etc. from overseas.

Extension line service setting

Make settings for holding & forwarding of the extension line service as well as a prefix.

* The extension line service is geared to corporations and requires a separate subscription contract.

- 1 In the standby screen,  ► [Phone] ► [Call log/Call settings] ► [Other settings] ► [Extension line service setting]

Hold & transfer	Set hold & transfer on or off. Also make hold prefix and dial-fixed prefix settings.
Prefix addition	Set prefix addition on or off. <ul style="list-style-type: none">● Register a new prefix:  ► [New registration] ► Set each item ► 

Phonebook

You can manage contacts.

Adding contacts to phonebook



- 1 In the standby screen,  ► [Phone] ► [Phonebook] ► [Add to Phonebook]
- 2 [Add new contact] / [Add to the existing contact]
 - When [Add to the existing contact] is selected, select a contact.
- 3 Set each item

Last name	Enter a family name.
First name	Enter a first name.
Phone	Register a phone type and number.
Mail	Register a mail address type and address.
Favorites	Register to Favorites.
Group	Register by group.
Illumination	Set a lighting pattern and the color.
Ringtone	Set a ringtone. <ul style="list-style-type: none">● Select [Add ringtone] to select ringtone from the Data Folder or Sound Recorder.

Event	Register a birthday, anniversary, etc.
Address	Register a postal code and address.
Memo	Register a memo.
Nickname	Register a nickname.
Organization	Register an organization such as a company, etc.
Website	Register a URL.
(Images)	Register an image. <ul style="list-style-type: none"> ● Set an image to be displayed when checking the contact or using SMS.



4

Searching the phonebook

- In the standby screen,  ► [Phone] ► [Phonebook] ► [Search contacts] / [Group list]
 - Change the display method:  ► [Verify/setting] ► [Switch display method] ► [All Contacts] / [Group list]

Checking/using the phonebook

You can retrieve saved contacts from the phonebook to make calls and send mail.

- In the standby screen,  ► [Phone] ► [Phonebook] ► [Search contacts] / [Group list]
 - The phonebook list is displayed.
 - Alternatively, in the standby screen, press .

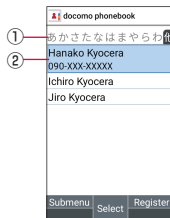

50 syllables

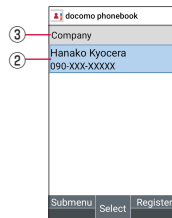

Groups

- ① **Tabs**
 - Switch tabs with .
- ② **Contact**
- ③ **Group name**

- ② **Select a name**

3 Check/use registered information

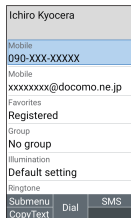

Contact details

Making a call

- 1 In the contact details, select a phone number

Creating/sending SMS

- 1 In the contact details, point the cursor to a phone number ▶

Creating/sending mail

- 1 In the contact details, select a mail address ▶ [docomo mail] / [PC Mail]

Editing contacts

- 1 In the contact details, ▶ [Edit contact] ▶ Set each item ▶
 - Items that can be set →P. 71

Deleting contacts

- 1 In the phonebook list, point the cursor to a name ▶ ▶ [Delete contact] ▶ [Delete 1] ▶ [OK]
 - Delete selected items: In the phonebook list, ▶ [Delete contact] ▶ [Delete selection] ▶ Select the name ▶ ▶ [OK]
 - Delete all: In the phonebook list, ▶ [Delete contact] ▶ [Delete all] ▶ [OK]

Backing up/restoring phonebook

- 1 In the phonebook list, ▶ [SD/SIM card/common]

Backup/ restore to SD card	Backup/restore to SD card →P. 96
Restore from SIM card	Import contacts from SIM card.
Send all data (common)	Export all contacts.

Using groups

- 1 In the standby screen, **[MENU]** ▶ **[Phone]** ▶ **[Phonebook]** ▶ **[Group list]**

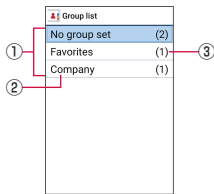

Group list

- 1 Groups
- 2 Group name
- 3 Number of contacts in group

Adding groups

- 1 In the group list, **[MENU]** ▶ **[Add group]** ▶ **[Group name]** ▶ Enter a group name ▶ **[OK]**
- 2 Point the cursor to a group ▶ **[MENU]** ▶ **[Add, delete to group]** ▶ Select the name ▶ 
 - Rename group: In the group list, point the cursor to a group ▶ **[MENU]** ▶ **[Change group name]** ▶ Enter a group name ▶ **[OK]**

- Delete a group: In the group list, point the cursor to a group ▶ **[MENU]** ▶ **[Delete group]** ▶ **[OK]**
- Rearrange a group order: In the group list, point the cursor to a group ▶ **[MENU]** ▶ **[Move the display position up]** / **[Move the display position down]**

Registering/unregistering contacts

- 1 In the group list, point the cursor to a group
- 2 **[MENU]** ▶ **[Add, delete to group]** ▶ Select the name ▶ 

NOTE

- You cannot change group name, delete a group, etc. with **[No group set]** or **[Favorites]**.

Mail/web browser



Use docomo mail, SMS, etc. to send/receive messages, and use the web browser to view web pages.

docomo mail

You can send and receive mail using a DOCOMO mail address (@docomo.ne.jp). Exchanged mail is saved to a DOCOMO mail server, so you can easily migrate data when changing to a new device, or restore data if the handset is misplaced. With a d ACCOUNT, you can use the same email address across several devices such as the handset and a PC browser to send, receive, and view email.







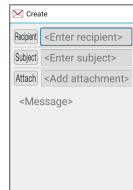







- For details on docomo mail, refer to the NTT DOCOMO website.
https://www.docomo.ne.jp/service/docomo_mail/ (in Japanese only)
- When Welcome to docomo mail! screen is displayed, confirm the contents and press .

Creating/sending docomo mail

- 1 In the standby screen, 
- 2 [Create new mail]
 - Alternatively, press  to display the mail creation screen.



Mail creation screen

- 3 Select the recipient field
- 4 Select recipient adding option ▶ Enter a recipient ▶  ▶ 
 - Add recipient:  ▶ Select a recipient adding method ▶ Enter a recipient ▶  ▶ 
 - Delete one recipient: Point the cursor to a recipient ▶  ▶ [Delete 1] ▶ [Yes] ▶ 
 - Delete selected recipients:  ▶ [Delete selection] ▶ Select recipients ▶  ▶ [Yes] ▶ 
 - Delete all recipients:  ▶ [Delete all] ▶ [Yes] ▶ 
- 5 Select the subject field ▶ Enter a subject
- 6 Select the message field ▶ Enter a message
- 7 
 - Save as draft: 

Attachments

Attach still pictures, videos, etc. to docomo mail to send.

- Some files cannot be attached depending on the file format.

1 In the mail creation screen, select the attachment field

2 Select a file to attach

Picture/Image	Attach shot still pictures, or downloaded images.
Video	Attach videos.
Phonebook	Attach the phonebook contacts.
Other files	Attach various-format files saved in the handset or microSD card.

3 

■ Adding an attachment file

1 In the mail creation screen, select the attachment field



2  ▶ Select a file to attach ▶ 

■ Deleting an attachment file

1 In the mail creation screen, select the attachment field

2 Point the cursor to an attachment file ▶

 ▶ [Delete 1] ▶ [Yes] ▶ 

- Delete selected files:  ▶ [Delete selection] ▶ Select attachment files ▶  ▶ [Yes] ▶ 
- Delete all files:  ▶ [Delete all] ▶ [Yes] ▶ 

Decorating messages (Deco-mail®)



You can decorate a mail message by inserting images, changing text color, font size, or background color, etc.

1 In the mail creation screen, select the message field

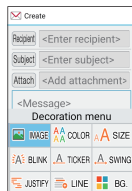
2  ▶ [Deco] ▶ Select a decoration ▶ Decorate



Decoration menu

- Decorate entered text:  ▶ [Select area(Copy etc)] ▶ Select a start point to decorate ▶ [Deco] ▶ Select a decoration ▶ Decorate ▶ 

Submenu operations on mail creation screen



1 In the mail creation screen, 



Switch to view screen	Switch to docomo mail menu screen.
Preview	Display a docomo mail that is being created in preview.
Save as draft	Save a docomo mail that is being created as a draft in "Drafts".
Template	Use Deco-mail® templates to create Deco-mail® or save a docomo mail that is being created as a template.
End editing without saving	End creating docomo mail without saving docomo mail that is being created.

Receiving docomo mail

docomo mail is automatically received.

1 Receive docomo mail automatically

- The notification counter  appears in the standby screen and  in the status bar.
- Not receive automatically: In the standby screen,  ▶ [Mail settings] ▶ [Communication setting] ▶ [Auto reception setting] ▶ [Confirm every time] / [OFF]

2 In the standby screen,  ▶ Select the notification counter 

- Alternatively, in the standby screen,  ▶ [Inbox] to check.

3 Select a folder ▶ Select an unread docomo mail

Inquiring for new mail



You can retrieve new docomo mail from the center that is sent when you are out of service area, the handset is turned off, etc.

1 In the standby screen,  (at least 1 second)

- Alternatively, in the standby screen,  ▶ [Check new mail / Update] to retrieve mail.

+Message

You can send/receive images, videos, stamps, etc. as well as text message in chat format using a mobile phone number as a recipient. In addition, you can exchange messages not only on one-to-one, but also among multiple people as group messages. If the other party is not a +Message user, you can send/receive messages via Short Message Service (SMS) with +Message application.

- For details on +Message, in the standby screen,  ▶ [Mail] ▶ Open +Message in [+Message(SMS)],  ▶ [How to use] ▶ [Use guide] to see the guide, or refer to the NTT DOCOMO website.
https://www.docomo.ne.jp/service/plus_message/ (in Japanese only)



+Message screen

- 1 In the standby screen,  ▶ [Mail] ▶ [+Message(SMS)]



- 1 **Profile image**
 - The profile image of the other party is displayed.
A profile image registered by the other party takes precedence over the one you registered to a contact.
- 2 **Message**
 - Display the message screen.
- 3 **Submenu**
 - Display the submenu to make settings for each recipient.
- 4 **New Msg**
 - Create a new message or new group message.
- 5 **MyPage**
 - Display My Page. In My Page, edit your profile/ settings and use the sticker store, etc.

Sending a message

- 1 In the standby screen,  ▶ [Mail] ▶ [+Message(SMS)]
- 2  ▶ [New message] / [New group message]
 - Group message is a function which allows you to exchange messages among +Message service users.

3 Select a recipient

- To send to a recipient who is not registered to contacts, select [Search] and enter a phone number directly.
- For group message, select recipients and press [⊞]. ([➕] is displayed on contacts using +Message.)

4 [⊞] ▶ Enter a message ▶ [⊞] ▶ [⊞]

If a recipient is a +Message user, you can send photos, videos, or stickers.



● Menus on +Message screen

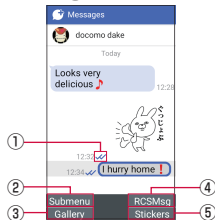

① Delivery status of message

- [✓]: The other party have read the message
- [✓]: Message is received on the other party's device
- [(No icon)]: Message is sent to the server
- [✗]: Sending message failed

② Submenu

Display the submenu.

- Register contacts, change notification settings, attach photos or videos, etc.

③ Gallery

Switch to the image selection screen.

④ RCSMsg

Enter a message.

⑤ Stickers

Switch to the sticker selection screen.

Short Message Service (SMS) information

- SMS can be also sent to or received from the parties using overseas network operators. For details on countries/regions and carriers where service is available, see the NTT DOCOMO website.
- If destinations are devices owned by those who use network of overseas network operators, enter "+", the "country code" and then the "recipient's mobile phone number".
If the phone number begins with "0", enter the phone number omitting the first "0". Alternatively, enter "010", the "country code", and the "recipient's mobile phone number" to send an SMS.
- You cannot send an SMS message to recipients with "# " or "* " included.
- You cannot send an SMS message to a recipient whose phone number with 184/186 prefixed.

+Message information



- To use +Message application via international roaming, set [Enable +Message service while roaming] to ON (it is set to OFF by default). Also, set [Data roaming] in the handset to ON.
- Before receiving messages, activate +Message application and agree with the +Message terms of use, etc. even if you have used +Message on the previous handset before model change or MNP transfer.

Reading a message



Sent/received messages are displayed in thread by recipient/sender.

- 1 In the standby screen,  ► [Mail] ► [+Message(SMS)]
- 2 Select a thread including the message you want to read
 - For functions used when replying to the message, refer to Step 4 in "Sending a message" (→P.79).



Forwarding a message

- 1 In the standby screen,  ► [Mail] ► [+Message(SMS)]
- 2 Select a thread including the message you want to forward
- 3 With the message to forward selected,  ► [Message options] ► [Forward to another message]
- 4 Select a recipient ► 



Deleting a message

- 1 In the standby screen,  ► [Mail] ► [+Message(SMS)]
- 2 Select a thread including the message you want to delete
- 3 With the message to delete selected,  ► [Message options] ► [Delete] ► [Delete]
 - Only messages on the handset can be deleted. You cannot delete messages on the recipient device. Note that deleted messages cannot be restored.

Deleting a thread



- 1 In the standby screen,  ► [Mail] ► [+Message(SMS)]
- 2 With the thread to delete selected,  ► [Delete]
 - Continue by following the instructions on the screen.
 - If you delete a thread of group message, you will be left from the group.

Changing +Message settings



- 1 In the standby screen,  ► [Mail] ► [+Message(SMS)]
- 2  ► [Settings]

Message	Set for messaging, Backup/Restore, etc.
Photos and videos	Set for file attachment, etc. such as photos or videos when sending/receiving.
Screen display	Set theme color or background image of the message screen.
Notification	Set for notifications.
Privacy	Set passcode, block, etc.
Others	Set transfer of user information, or initialize +Message service, etc.

Downloading stickers

- 1 In the standby screen,  ► [Mail] ► [+Message(SMS)]
- 2  ► [Sticker store]
- 3 Select a sticker you like from [Ranking], [New], or [Categories] ► 





Using stickers

- 1 In the standby screen,  ► [Mail] ► [+Message(SMS)]
- 2 Select a thread for which you want to use stickers
- 3  ► Select a sticker
 - If you use a sticker not included in the sticker history,  ► Select a sticker.



PC mail

Configure a mail account provided by a service provider to exchange mail.

Setting up mail account







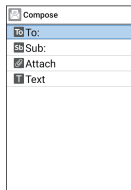

- 1 In the standby screen,  ► [Settings] ► [More settings] ► [Accounts] ► [Add account] ► [PC Mail]
- 2 Enter an email address
- 3 Enter the password ► 
- 4 Set up the account ► 
- 5 Enter the account name and displayed name ► 

Creating/sending mail

- 1 In the standby screen,  ► [Mail] ► [PC Mail]
- 2 





PC mail creation screen

- 3 Select the recipient field ▶ [New]
- 4 Select recipient adding option ▶ Enter a recipient ▶ 
 - Add recipient: [New] ▶ Select an recipient adding option ▶ Enter a recipient
 - Delete one recipient: Point the cursor at the recipient ▶  ▶ [Delete] ▶ [Delete one] ▶ [Yes]
 - Delete selected recipients:  ▶ [Delete] ▶ [Delete multiple] ▶ Select recipients ▶  ▶ [Yes]
 - Change recipient type: Point the cursor at the recipient ▶  ▶ [Change to To] / [Change to Cc] / [Change to Bcc]
- 5 Select the subject field ▶ Enter a subject
- 6 Select the message field ▶ Enter a message
- 7 
 - Save as a draft:  ▶ [Save as draft] ▶ [Yes]
 - Discard mail being created:  ▶ [Yes]

- Enter common phrases:  ▶ [Quotation] ▶ [Phrase] ▶ Select phrase

Attachments

Attach still pictures, videos, etc. to PC mail to send.

- Some files cannot be attached depending on the file format.
- 1 In the mail creation screen, select the attachment field
 - 2 [Add new] ▶ [Pictures] / [Videos] / [Audio] / [Record audio] / [Others] ▶ Select the file to attach
 - 3 
 - Adding an attachment file
 - 1 In the mail creation screen, select the attachment field
 - 2 [Add new] ▶ [Pictures] / [Videos] / [Audio] / [Record audio] / [Others] ▶ Select the file to attach ▶ 
 - Deleting an attachment file
 - 1 In the mail creation screen, select the attachment field
 - 2 Point the cursor to an attachment file ▶ 

Receiving/displaying mail

- 1 In the standby screen, [MENU] ► [Mail] ► [PC Mail]
- 2 Select a tray/folder ► Select the mail

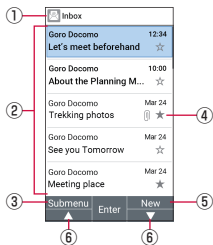

- 1 Displayed tray name/folder name
- 2 Mail
 - For unread mail, the sender and subject appear in bold.
- 3 Submenu
 - Reply, delete, switch accounts, make settings, etc.
- 4 Star icon
 - Use it as a mark indicating that the mail is special or supposed to be dealt with later.
 - You can check starred mails in the Starred folder.
- 5 New
 - Create new mail.
- 6 ▲/▼
 - Scroll the page.



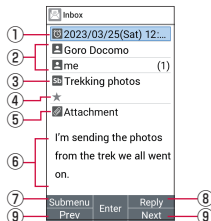

3 Checking mail

- If "VIEW ENTIRE EMAIL" is displayed in the message field, select "VIEW ENTIRE EMAIL" to show entire mail text.





- 1 Date/time received
- 2 Destination/sender
- 3 Subject
- 4 Star icon
 - Use it as a mark indicating that the mail is special or supposed to be dealt with later.
 - You can check starred mails in the Starred folder.
- 5 Attachment
- 6 Text body
- 7 Submenu
 - You can reply to all, forward, add/remove star, etc.
- 8 Reply
- 9 Previous/Next
 - Display the previous/next mail screen.



Replying to/forwarding mail

- 1 In the standby screen,  ► [Mail] ► [PC Mail]
- 2 Select a tray/folder ► Select the mail
- 3 
 - Reply to all:  ► [Reply all]
 - Forward:  ► [Forward]
- 4 Create the mail
- 5 

Deleting mail

- 1 In the standby screen,  ► [Mail] ► [PC Mail]
- 2 Select a tray/folder
- 3  ► [Delete] ► Select the mail
- 4  ► [Yes] ► [OK]

Mail settings

- 1 In the standby screen,  ► [Mail] ► [PC Mail]
- 2  ► [Settings] ► [General settings]

Set default account	Set the default account to use.
Include original text	Enable quoting of a message when replying to it.
Attachment storage	Set where attachments are saved.
Auto-fit messages	Enable automatic adjustment of text size.
Confirm before deleting	Enable confirmation to be displayed when deleting mail.
Confirm before sending	Enable confirmation to be displayed when sending mail.

Web browser

You can display websites via packet communication and Wi-Fi.

- If  does not work when using the web browser, enabling the pointer may enable the cursor operation (→P. 34).
- Websites may not be displayed correctly.

dmenu

In dmenu, you can easily access websites recommended by DOCOMO or the customer support.













1 In the standby screen, ▶ [Homepage]

- Web browser activates and "dmenu" is displayed.
- If confirmation appears, follow the instructions on the screen.
- You can also set the website that appears after selecting [Homepage] (→P. 88).

NOTE

- To use dmenu, check that the handset is connected to the network (→P.37).
- Packet communication charges are required separately for connecting to dmenu or using presented contents. Some contents you use may initiate packet communication automatically.
- Contents presented on dmenu include paying contents.

Website operations

- Move page display up/down:  / 
- Return page: 
- Advance page:  ▶ [Forward]
- Reload page:  ▶ [Refresh]
- Change video playback volume (Down/Up):  / 
- Zoom in/out:  / 
- Enlarge/shrink text:  / 
- Display web page details:  ▶ [Page operation] ▶ [Page info]
- Display guide: 

Opening new tabs

1 In a website, ▶ [New tab]

- When several tabs are opened, in a website,  ▶ [Tab list] ▶ Select [Create new tabs].

Switching tabs

1 In a website, ▶ [Tab list]

2 Select a tab



- Alternatively,  /  to switch tabs.

Closing tabs



1 In a website, ▶ [Tab list] ▶ Point the cursor to a tab ▶

Web searching/URL entry



You can enter a URL directly to display a website. Also, enter a keyword to search website information.

- 1 In a website,  ▶ [Search/Enter URL]
 - Alternatively, in the standby screen,  ▶ [Web Search] to display a website.
- 2 Enter keyword/URL
 - To search by entering keywords, use the search engine set in [Set search engine] of [Advanced] in web settings.



Saving images

- 1 In a website,  ▶ [Page operation] ▶ [Save image]
 - Switches to image saving mode.
- 2 Select an image with the pointer
 - Operate with .
 - After saving an image, select [View the saved data] to check the saved image.

Copying text

- 1 In a website,  ▶ [Page operation] ▶ [Copy text]
- 2 Select a start point with the pointer
 - Operate with .
- 3 Specify a range to copy
- 4  ▶ [OK]

Text search in a webpage

- 1 In a website,  ▶ [Page operation] ▶ [Find on page]
- 2 Enter keywords
 - Move to keywords with [] / [.

Using bookmarks



Saving as a bookmark

- 1 In a website,  ▶ [Save to bookmarks] ▶  ▶ [OK]

Displaying websites from bookmarks



- 1 In a website,  ▶ [Bookmarks/History] ▶  to display "Bookmarks" tab
 - Alternatively, in the standby screen,  ▶ [Bookmarks] to display tab.
- 2 Select bookmark

Using website viewing history

- 1 In a website,  ► [Bookmarks/History] ►  to display "History" tab
 - Alternatively, in the standby screen,  ► [History] to display tab.
- 2 Select a day of viewing / [Most visited] ►
Select a viewing session

Setting a homepage

You can also set the website that appears after selecting [Homepage].

- 1 In the website to set,  ► [Web settings]
 - Alternatively, in the standby screen,  ► [Web settings] to display this.
- 2 [Set homepage] ► [Current page]

Web settings

Set the browser.

- 1 In a website,  ► [Web settings]
 - Alternatively, in the standby screen,  ► [Web settings] to set this.

Set homepage	Set homepage →P. 88
Storage	Set where files are saved.
Privacy & security	Set functions that use browsing information for the purpose of improving convenience.
Change text size	Set the text size.
Advanced	Make search engine and website display settings.
Load images	Enable displaying images on a web page.
Exit confirm	Enable confirmation to be displayed when exiting the browser.

Displaying download history

Check history of downloaded images, etc.

- 1 In a website,  ► [Downloads]
 - Alternatively, in the standby screen,  ► [Downloads] to display history.
- 2 Select a download

Tools/Apps

Calendar

Display a calendar and manage a schedule.

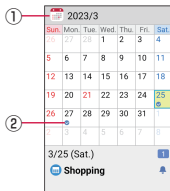

Displaying the calendar

- 1 In the standby screen,  ► [Calendar]
- 2 Check the calendar





- 1 Displayed year and month
- 2 Registered schedule event

Operations in the calendar

- Display registered events: Select a date that has a schedule event registered
- Jump to the previous/next month:  / 

Registering new schedule events

- 1 In the calendar, 
- 2 Set each item ► 

When a scheduled time arrives



Set an alarm for a scheduled event to notify you when a set event has arrived. Press either key to stop the alarm.

Using the calendar menu

- 1 In the calendar, 

Add	Creating a schedule →P. 90
Previous	Jump to the calendar display for previous month.
Next	Jump to the calendar display for next month.
Jump to	Jump to the calendar display for the specified date.
Conditions	Set display conditions.
To memo list	Display the memo list.
To i-sch list	Display the i-schedule list.
Delete all	Delete all schedules.
Settings	Set/check the alarm sound, ring time, birthday data, cloud settings, help, etc.

Deleting from the schedule



- 1 In the calendar, select the date
- 2 Point the cursor to the schedule event ▶ 
- 3 [Delete] ▶ [Delete one] ▶ [Delete]
 - Delete selected items: [Delete] ▶ [Delete selected]
▶ Select schedules to delete  ▶ [Delete]
 - Delete all items: [Delete] ▶ [Delete all] ▶ [Delete]

Calculator

- 1 In the standby screen,  ▶ [Calculator]
- 2 Use the calculator

Alarm

Be prompted with an alarm or handset vibration at a specified time.

- 1 In the standby screen,  ▶ [Tools] ▶ [Alarm]
- 2 Point the cursor to an unregistered alarm ▶ 
 - Add an unregistered alarm:  ▶ [Add]
- 3 Set each item

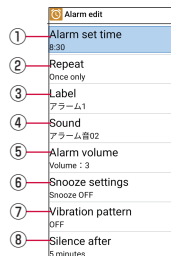

- ① **Time alarm sounds at**
 - Set the alarm time.
- ② **Repeat**
 - Set the alarm to repeat.
- ③ **Alarm name**
 - Enter an alarm name.
- ④ **Alarm sound**
 - Set the alarm sound.

- ⑤ **Alarm volume**
 - Set the alarm volume.
- ⑥ **Snooze**
 - Enable an alarm to be snoozed.
- ⑦ **Vibration pattern**
 - Enable the handset to vibrate.
- ⑧ **Alarm time length**
 - Set the alarm time length.

4

NOTE

- An alarm does not sound if the handset is not powered on at the set alarm time.
- An alarm does not sound if the alarm volume is set to "0" or if you disabled Prioritize alarm while in Manner mode.

Stopping an alarm



When the time for an alarm arrives, the alarm sounds and the handset vibrates.

- 1 **Press either key** 
 - When snoozing is set, long-press  to stop snoozing.

While in Manner mode

- 1 In the alarm screen,  ► [Settings]
- 2 [Prioritize alarm]

Deleting an alarm



- 1 In the alarm screen,  ► [Delete] ► [Delete multiple]
 - Delete an item: In the alarm screen, point the cursor to the alarm to delete ►  ► [Delete] ► [Delete one] ► [YES] ► [OK]
- 2 Select the alarm to delete ►  ► [YES] ► [OK]

Enabling/disabling alarms

- 1 Point the cursor to an alarm, 

Countdown timer

Be notified with an alarm or handset vibration after the specified length of time passes.

- 1 In the standby screen,  ► [Tools] ► [Countdown Timer]
- 2 Select the countdown timer to use
 - To stop countdown: 
 - To reset countdown: 
 - Be notified with an alarm or handset vibration once the specified length of time passes. To stop the timer, press .

Registering countdown timers

- 1 In the countdown timer screen,  ► [Add]
 - Point the cursor to a countdown timer, and press  to edit.
- 2 Set each item ►  ► [OK]

Deleting countdown timers







- 1 In the timer screen, point the cursor to the countdown timer to delete ► 
- 2 [Delete] ► [YES] ► [OK]

While in Manner mode

- 1 In the countdown timer screen,  ► [Settings]
- 2 [Prioritize timer]

Stopwatch

You can use the stopwatch to time laps and split times.



- 1 In the standby screen,  ► [Tools] ► [Stopwatch]
- 2 
 - Time laps, split times: 
- 3 
 - Resume timing: 
 - Reset timing: 
 - Send timed results: 

NOTE

- You can record a history of up to 99 lap times and split times.

World clock



Register times of multiple cities in the world and check them.

- 1 In the standby screen,  ► [Tools] ► [World clock]
- 2  ► [Add cities]
 - Select [Sort] to rearrange the order.
 - Select [Delete] to delete a city.
- 3 Check cities to add ►  ► [OK]
 - You can also search a city using the search box.



Notepad

Create and manage notes.





Registering a note

- 1 In the standby screen,  ► [Notepad]
- 2  ► Enter the note ► 

Checking notes

- 1 In the standby screen,  ► [Notepad]
- 2 Select a note
 - Edit notes: Select a note ► 



Deleting notes

- 1 In the standby screen,  ► [Notepad]
- 2 Select a note ►  ► [Delete one] ► [OK]
 - Delete selected: In the note screen,  ► [Delete] ► [Delete selected] ► Select notes ►  ► [Delete]
 - Delete all: In the note screen,  ► [Delete] ► [Delete all] ► [Delete]



Sound recorder

You can use the sound recorder function to take memos in meetings or negotiations.

- Available time per recording is up to approximately 3 hours. The maximum savable number of recordings differs with the available handset memory/microSD card.

- 1 In the standby screen,  ► [Sound Recorder]
- 2 [Record] ► 
 - If a microSD card is installed, select whether to save recording data to the card.
- 3  ► [OK]
 - Recording data is saved and the playback screen appears.
 - If you close the handset, or if a call arrives, or if an alarm sounds during recording, the data is saved and recording stops.

Playing recording data

- 1 In the standby screen,  ► [Sound Recorder] ► [Play]
- 2 Point the cursor to recording data ► 
 - The recording data plays back.
 - Pause/resume: 

- Rewind 5 seconds:
- Adjust the volume:
- Jump to specified time: ▶ [Jump to specific time]
▶ Enter the time ▶
- In the screen for selecting recording data, press to switch file display (handset/microSD card).

Sending recording data

- 1 In the playback screen,
- 2 [+メッセージ(SMS)] / [Bluetooth] / [docomo mail] / [PC Mail]

Deleting recording data

- 1 In the recording data list, point the cursor to the recording data to delete ▶ ▶ [Delete]
- 2 [Delete one] ▶ [Yes] ▶ [OK]
 - Delete selected items: [Delete multiple] ▶ Select the recording data to delete ▶ ▶ [Yes] ▶ [OK]

Checking recording data details

- 1 In the recording data list, point the cursor to the recording data to check ▶ ▶ [Details]

Weather

Check weather information in the current location or specified area.



- 1 In the standby screen, ▶ [Tools] ▶ [Weather]

Operations on weather screen

- : Display the city list or make settings such as temperature scale, refresh time, etc.
- : Refresh weather information.
- : Toggle display by week/day.

Kanji check

You can enlarge a Kanji character with a lot of stroke counts to display and check it. You can check 100 characters at once.

- 1 In the standby screen,  ► [Tools] ► [Kanji Check]
- 2 Enter a Kanji to check ► Select a character with 



An entered character is displayed one by one on the Kanji check screen.

NOTE

- Press  on the Kanji check screen to edit the entered character.

OfficeSuite

View Word, Excel, and other files.

- 1 In the standby screen,  ► [Tools] ► [OfficeSuite]
- 2 Select the file
 - Use the pointer in OfficeSuite.
 - Edit a file: Open the file to edit, 
 - Create a new file:  ► [Create document] ► Select "Blank" for the file to create

SD card backup

Use a microSD card to migrate phonebook entries, images, and other data or back up such data.

- Data which can be backed up to/restored from microSD Card is as follows.
 - Phonebook
 - docomo mail (local)
(received mail/sent mail/unsent mail)
 - Media files (image/video/music)
 - Call history
 - Schedule/memo
 - +Message
- When no microSD card is installed, images, videos, music data, etc. are saved to the handset memory. When you back up to microSD card, only the data saved on the handset memory is backed up. Data saved to a microSD card is not backed up.

- 1 In the standby screen,  ► [Tools] ► [SD card backup]

NOTE

- Do not remove the battery pack from the handset while backing up or restoring data. Data on the handset may be damaged.
- When the battery level is low, backing up or restoring data may fail. In this instance, charge the handset first and then back up or restore data.

Backing up data to microSD card

- Install a microSD card in advance.

1 In the SD card backup screen, [Backup]

2 Select a data category to save

3  ▶ [Backup]

4 

NOTE

- When backing up the phonebook to microSD card, you cannot copy phonebook data without name.
- If memory on the microSD card is insufficient, backing up or restoring may fail. In this instance, ensure enough space by deleting unnecessary files from the microSD card.

Restoring data to the handset

- Install the microSD card with backed up data in advance.
- When restoring phonebook entries, you can also restore files created with PhoneBookCopy or with a function in an i-mode device which allows you to back up data to microSD card.

1 In the SD card backup screen, [Restore]

2 [SELECT] for a data category to restore

3 Select backup files ▶ 

4 [Add] / [Overwrite]

5  ▶ [Restore]

6 

NOTE

- If phonebook items (telephone number, etc.) from another device differ from those on the handset, items may be changed or deleted. Characters that can be registered to phonebooks also differ between devices, and may be deleted when copied.

Data backup service

You can quickly back up important schedule, memo, and other data with automatic updating.

- For details on this data backup service, refer to the NTT DOCOMO website.

1 In the standby screen, ► [Tools] ► [Data Security]

- Continue by following the instructions on the screen.

Data switch

Transfer the data such as phonebook, etc. Send/receive data between handsets with the data switch app.

1 In the standby screen, ► [Tools] ► [Data Switch]

2 [Send data] / [Receive data]

Follow the instructions on the screen.

Device Control

Set the handset so it is optimized for work, such as limiting functionality that is not used for tasks.

- Enable Device Control when making initial settings (→P. 57).

To activate Device Control

- To activate Device Control, Device Control must be set to a custom key (→P. 59). Set a custom key in advance.

Setting with Device Control

1 Press the custom key (/ /) that has Device Control set

2 Enter the password

- The initial password is "000000".

3 Set the policy

Wi-Fi	Disable Wi-Fi and tethering.
Bluetooth	Disable Bluetooth and tethering.
Device	Disable SMS, software updates, USB tethering, USB MTP, SD card, and disapprove apps with an unknown provider.
Call	Limit mobile network, phonebook editing, and incoming/outgoing calls.

Apps	Limit activation of apps.
Reset	Disable data initialization.
Location	Lock location information settings as enabled.

NOTE

- Software may not update correctly if software updating is disabled and then re-enabled. Either update software from handset settings (→P.150), or power off the handset and power it on again (→P.52).
- Airplane mode is set to ON if you activate handset in safe mode. If activation of Settings app is limited, set Airplane mode to OFF from Quick settings (→P.120).



Checking the current policy

You can check the policy that Device Control is using.



- 1 In the Device Control screen,** 
- 2 [Status]**
 - The policy is displayed.

Transferring the set policy

You can transfer the set policy to another device that supports Device Control.

- 1 In the Device Control screen,** 
- 2 [Export policy]** 
 - If Wi-Fi or location settings are displayed, follow the onscreen instructions.
 - The QR code and the ID number are displayed.
- 3 On the receiving device, activate Device Control policy reception, and enter the ID number**
- 4 [Accept]**



Receiving the set policy on another device

- 1 With another device, transfer the Device Control policy, and display the ID number**
- 2 In the Device Control settings on the handset,** 
- 3 [Import policy]**
- 4 Enter the ID number displayed on the other device**  **[OK]**  **[OK]**
 - If Wi-Fi or location settings are displayed, follow the onscreen instructions.

NOTE

- Policy transfer/reception uses Wi-Fi. If Wi-Fi is limited, a pop-up appears; remove the limitation and then transfer/receive the policy.

Changing the password

- 1 In the Device Control screen, 
- 2 [Change password]
- 3 Enter the new password ▶ Re-enter the password ▶  ▶ [OK]

NOTE

- If password is forgotten, reset the handset. If resetting the handset is limited by policy, it cannot be reset. Contact "General Inquiries" on the back cover.

Handset Settings

Settings menu

In the standby screen, **[ME/NU]** ► **[Settings]** to display a menu and make handset settings.

Wallpaper/Display	Make settings for the screen display, etc.
Sound/Notification	Make settings for Manner mode, ringtone, vibration, etc.
Lock/Security	Make settings for the security lock.
Wireless/Network	Make settings for Wi-Fi, Bluetooth, mobile networks, etc.
docomo service	Make settings for docomo services.
Battery	Check the battery level, etc.
Custom key	Set custom keys (→P. 59).
About phone	Update software, check handset status, etc.
More settings	Make settings for location, date and time, etc.

Wallpaper/Display

Make settings for the screen display, etc.

- 1 In the standby screen, **[ME/NU]** ► **[Settings]** ► **[Wallpaper/Display]**

Wallpaper	Wallpaper →P. 101
Brightness level	Brightness level →P.102
Backlight time	Backlight time →P. 102
Key backlight	Enable the backlight.
Font size	Set the text size.
Sub display	Make settings for display pattern or set whether to display the caller ID/sender name on sub display.
Visibility adjustment	Apply clear color image quality.

Wallpaper





Set the image and clock appearing in the standby screen.

- 1 In the standby screen, **[ME/NU]** ► **[Settings]** ► **[Wallpaper/Display]** ► **[Wallpaper]**

Preset wallpapers	Select a standby screen image from images preserved at time of purchase.
Data Folder	Select a standby screen image from the Data Folder.
Set clock	Set the clock type to display.

Brightness level

Set the display brightness.

- 1 In the standby screen,  ► [Settings] ► [Wallpaper/Display] ► [Brightness level]
- 2   

NOTE

- Note that continuous stand-by time is shortened when the brightness of the screen is increased.

Backlight time

Set the light duration of the backlight.

- 1 In the standby screen,  ► [Settings] ► [Wallpaper/Display] ► [Backlight time]
- 2 Set the duration



NOTE

- Note that continuous stand-by time is shortened when the light duration is increased.

Sound/Notification

Make settings for Manner mode, ringtone, vibration, etc.

- 1 In the standby screen,  ► [Settings] ► [Sound/Notification]

Volume	Volume →P. 103
Manner mode	Manner mode →P. 103
Media sound in Manner mode	Enable the sound of video or music to play while in Silent mode or Drive mode.
Manner key long press action	Select to activate Manner mode or Silent mode when long pressing  or  for at least 1 second in the standby screen.
Phone ringtone	Set a ringtone.
Also vibrate for calls	Enable vibration for incoming calls.
Vibration pattern	Set the vibration pattern.
Incoming LED	Set the color of the LED when a call arrives.
Notification sound	Set the notification ringtone.
Pulse notification light	Enable a pulsing notification light.
Other sounds	Enable screen lock tone, keypress tones, etc.

Volume

Set the volume for call ringtone, calls, etc.

- 1 In the standby screen,  ► [Settings] ► [Sound/Notification] ► [Volume]
- 2 Select an item

Manner mode



Set handset sound to avoid disturbing others when in public.

- 1 In the standby screen,  ► [Settings] ► [Sound/Notification] ► [Manner mode]
- 2 Select the Manner mode





Manner mode	Ringtones and other handset sounds are muted; handset vibrates for incoming calls/messages, etc.
Silent mode	Ringtones and other handset sounds are muted; handset does not vibrate for incoming calls/messages, etc.
Drive mode	Ringtones and other handset sounds are muted; handset does not vibrate for incoming calls/messages, etc. When a call arrives, answering memo activates and a message plays to indicate that you are driving.
OFF	Exit the Manner mode.

- If the confirmation screen to select whether to enable the sound of video or music appears when Silent mode or Drive mode is selected, set following onscreen instructions.

Entering/exiting Manner mode with one touch

- 1 In the standby screen,  (at least 1 second)
 - The handset enters/exits Manner mode.
 -  (at least 1 second) to enter/exit Drive mode.

NOTE

- Pressing  in the standby screen displays the settings menu of Manner mode and you can set Manner mode.
- Long pressing  for at least 1 second with the handset closed, Manner mode you set previously is enabled. Long press  for at least 1 second again to disable Manner mode.
- Depending on the function, you can increase the volume of the media sound currently played back by pressing  even when "Do not ring" is selected for media playback while in Silent mode or Drive mode.

Lock/Security

Make lock and security settings.

- 1 In the standby screen,  ► [Settings] ► [Lock/Security]

Operation password setting	Operation password setting →P. 105
Lock screen	Lock screen →P. 106
Application lock	Application lock →P. 106
Usage restriction	Usage restriction →P. 106
Show passwords	Enable entered characters to be visible briefly as they are entered.
Device admin apps	Enable device administration apps.
SIM card lock	SIM card lock →P. 107
Encryption & credentials	Encryption & credentials →P. 107
Trust agents	Manage trust agents.
Screen pinning	Set to keep only screen of a specified app in view.
Apps with usage access	Manage apps that can access app usage history data.

Operation password setting

Some functions for convenient use of the handset require security codes. In addition to a security code for handset operation, there are codes such as a network access code for network services. Use the different codes and get the most out of your handset.

- Security codes and PIN code for various functions are displayed as [·].

■ Precautions about security codes

- Avoid setting security codes that are easy to guess, such as a birthday, part of a phone number, address/room number, "1111", and "1234". Keep a separate memo of security codes.
- Keep security codes private. If security codes are misused by others, DOCOMO shall not be responsible for any resulting damages.
- If you forget your security codes, visit a docomo Shop with documentation showing you are the contracted subscriber (driver's license, etc.), the handset, and the nano SIM card.
For details, contact the contacts on the back cover.
- The PUK (Personal Unblocking Key) is indicated on the application (customer copy) you received when you subscribed at a docomo Shop. If you subscribed at a location other than a docomo Shop, either visit a docomo Shop with documentation showing you are the contracted subscriber (driver's license, etc.) and the nano SIM card, or contact the contacts on the back cover.

d ACCOUNT password

d ACCOUNT is an account usable with docomo apps. You set an arbitrary password for your d ACCOUNT during your initial settings, but you can change the Password at anytime (→P. 114).

- For details on d ACCOUNT, refer to the NTT DOCOMO website.

Application lock number (operation password)

If you set any restrictions, you need to enter the application lock number to temporarily disable them. You can change the code (→P. 105).

- If you enter the wrong security code five times continuously, you cannot enter it for 30 seconds.

Network security code

A four-digit code required such as when verifying a subscriber's identity when visiting a docomo Shop, docomo information center, or "customer support", or when using network services. You set an arbitrary number when subscribing, and you can also change the number.

- For details on the network security code, refer to the NTT DOCOMO website.

SIM PIN

A nano SIM card has a security code called PIN code. It is set to [0000] when subscribing, but you can also change the number (→P. 107).

The SIM PIN is a four- to eight-digit security code that needs to be entered for recognizing the user of the nano SIM card every time a card is inserted or when the handset is turned on to prevent unauthorized use of the nano SIM card by a third party. Enter the SIM PIN to enable sending/receiving and handset operation.

- If inserting a nano SIM card that has been used in another device, use the previously set SIM PIN. It is [0000] if the setting has not been changed.
- If you enter a wrong PIN code three times continuously, it is locked and the nano SIM card cannot be used. If the card becomes locked, enter the Personal Unblocking Key (PUK).

PIN Unblocking Key (PUK)

An eight-digit code for unlocking the card if it becomes locked. You cannot change the code.

- If you enter the wrong key 10 times continuously, the nano SIM card is completely locked. If the card is completely locked, visit a docomo Shop.

Operation password setting

- 1 In the standby screen,  [Settings] ▶ [Lock/Security] ▶ [Operation password setting]

2 Enter the current application lock number



- If no application lock number is unset, entering a current application lock number is not required.

3 Enter the new application lock number



4 Enter the new application lock number again



Lock screen

1 In the standby screen, [Settings] [Lock/Security] [Lock screen]

None	The lock screen is not displayed.
PIN	Set a four- to sixteen-digit number.
Password	Set four to sixteen digits of alphanumeric and en-width symbols* including one or more letters. * Some en-width symbols are not available.

NOTE

About [Lock screen]

- If you enter the wrong security code five times continuously, you cannot enter it for 30 seconds. If you forget the PIN/password, contact a docomo Shop.

Application lock

1 In the standby screen, [Settings] [Lock/Security] [Application lock]

2 Enter the application lock number



3 Checkmark the function to lock

Usage restriction

1 In the standby screen, [Settings] [Lock/Security] [Usage restriction]

2 Enter the application lock number



3 Checkmark the function to lock

- If you selected "PC Mail account lock", select a permission range from "Allow all", "Allow only specific domains", and "Restrict all". When selecting "Allow only specific domains", press  and save the domain to permit.

NOTE

- You can call to an emergency number (110, 119, or 118) even when you set a restriction on outgoing calls.

SIM card lock

Make settings for the SIM PIN.

- 1 In the standby screen,  ► [Settings] ► [Lock/Security] ► [SIM card lock]

Lock SIM card	Set the handset to require a SIM PIN when powering on.
Change SIM PIN	Change the SIM PIN.

NOTE

- In Japan, you cannot call to an emergency number (110, 119, or 118) when a nano SIM card is not inserted, while the SIM PIN is locked, or from the PUK (PIN Unlocking Key) entry screen.
- The setting is saved on the nano SIM card.

If the handset becomes PIN-locked

- 1 In the PIN-locked screen, enter the PUK (PIN Unlocking Key)
- 2 Enter a new SIM PIN
- 3 Enter the new SIM PIN again
- 4 

Encryption & credentials

- 1 In the standby screen,  ► [Settings] ► [Lock/Security] ► [Encryption & credentials]

Encrypt phone	Encrypt data on the handset. <ul style="list-style-type: none">• The handset is encrypted at time of purchase, and encryption cannot be cancelled or reset.
Encrypt SD card	Encrypt data on an SD card.
Storage type	Display the type of storage.
Trusted credentials	Display trusted CA certificates.
User credentials	Manage user credentials saved on the handset.
Install from SD card	Install certificates from SD card.
Clear credentials	Delete all credentials.

Wireless/Network

Make network settings such as Airplane mode and a VPN.

- 1 In the standby screen,  ► [Settings] ► [Wireless/Network]

Wi-Fi	Wi-Fi →P. 108
Bluetooth	Bluetooth →P. 125
Airplane mode	Airplane mode →P. 109
Mobile network	Mobile network →P. 110
Data usage	Data usage →P. 111
Restrict data	Set apps that have data restricted.
Tethering	Tethering →P. 112
VPN	VPN →P. 113

Wi-Fi

Connect to a home or office network or public wireless LAN service via an access point to use email and Internet, using handset Wi-Fi function.

■ Radio interference with Bluetooth devices



Wireless LAN (IEEE 802.11 b/g/n) and Bluetooth devices use the same frequency band (2.4 GHz). Using the handset near a Bluetooth device may cause interference, resulting in lower communication speed, noise, and poor connection. In this instance, do the following.

- Distance the handset and the Bluetooth device at least 10 m apart.
- If using the handset at less than 10 m, power off the Bluetooth device.

- 1 In the standby screen,  ► [Settings] ► [Wireless/Network] ► [Wi-Fi]

- 2 Checkmark [Wi-Fi function] to enable it

- 3 Select an access point

- If you select a security-protected access point, enter the password and press .
- To register access points manually: [Add network] ► Enter the network name ► Set security ► 

NOTE

- Depending on your environment, communication may be slow or unavailable.

- You can also use packet communication when Wi-Fi is on. If a Wi-Fi network is disconnected, the handset switches automatically to the mobile network. Note that continuing to use the handset with the connection switched may incur high packet communication fees.
- You can turn off the Wi-Fi function to reduce battery consumption.
- When using Wi-Fi, be sure to obtain an adequate signal.
- If you connect to an access point that is not connected to the Internet,  appears, and communication may be via the mobile network and not the Wi-Fi network.

Detailed settings

- 1 In the standby screen,  ► [Settings] ► [Wireless/Network] ► [Wi-Fi]
- 2 [Wi-Fi preferences]

Open network notification	Set the handset to display a notification icon when an open network is detected.
Install certificates	Install certificates.
Network rating provider	Set a network rating provider.
Wi-Fi Direct	Wi-Fi Direct →P. 109
MAC address	Check the MAC address.
IP address	Check the IP address.

Wi-Fi Direct

Connect to other Wi-Fi Direct-capable devices with the Wi-Fi function without an access point or the Internet.

- Available when [Wi-Fi] is enabled (→P. 108).
- 1 In the standby screen,  ► [Settings] ► [Wireless/Network] ► [Wi-Fi] ► [Wi-Fi preferences] ► [Wi-Fi Direct]
 - Continue by following the instructions on the screen.

Disconnecting

- 1 In the standby screen,  ► [Settings] ► [Wireless/Network] ► [Wi-Fi] ► [Wi-Fi preferences] ► [Wi-Fi Direct]
- 2 Select the connected access point ► [Yes]

Airplane mode

Restrict the use of some functions using communication such as call/mail functions.

- 1 In the standby screen,  ► [Settings] ► [Wireless/Network]
- 2 Checkmark [Airplane mode]

NOTE

[Airplane mode]

- If [Lock SIM card] is enabled, you cannot call an emergency number (110, 119, or 118). If it is disabled, you can call an emergency number (110, 119, or 118) even in Airplane mode. If you call an emergency number, [Airplane mode] is disabled and the call is made.
- The Wi-Fi and Bluetooth functions can be enabled even when [Airplane mode] is enabled.

Mobile network

Make settings for the calling mode, access points, etc.

- 1 In the standby screen,  ► [Settings] ► [Wireless/Network] ► [Mobile network]

Mobile data	Enable access to data via the mobile network.
Data roaming	Enable connection to a data service while roaming.
Call mode setting	Enable VoLTE for when calling.
Preferred network mode	Set a preferred network to connect to.
Select automatically	Automatically selects the optimal network.
Network	Select the network manually.
Access Point Names	Access Point Names → P. 110

Access point settings

Access points for connecting to the Internet (docomo) are pre-registered. Add access points as required. For details of sp-mode, refer to the NTT DOCOMO website. <https://www.docomo.ne.jp/service/spmode/> (in Japanese only)

To use mopera U or Business mopera Internet, you must add an access point manually.

For details on mopera U, refer to the mopera U website. <https://www.mopera.net/> (in Japanese only)

- Checking the access point that is currently used

- 1 In the standby screen,  ► [Settings] ► [Wireless/Network] ► [Mobile network] ► [Access Point Names]

- Setting additional access points <New APN>

- Do not change MCC to a value other than 440, or MNC to a value other than 10. They will no longer appear on the screen.

- 1 In the standby screen,  ► [Settings] ► [Wireless/Network] ► [Mobile network] ► [Access Point Names]

- 2  ► [New APN]

- 3 [Name] ► Enter the name of the network profile to create ► 

- 4 [APN] ► Enter the access point name ► 



5 Enter other items required by network operators ▶ 

NOTE

- If the MCC or MNC settings are changed and they no longer appear on the screen, either reset the handset to its initial settings, or set access points manually.

Resetting access points

Initializing access points returns them to their settings at time of purchase.

- 1** In the standby screen,  ▶ [Settings] ▶ [Wireless/Network] ▶ [Mobile network] ▶ [Access Point Names]
- 2**  ▶ [Reset to default]

Data usage

Your data on mobile networks and Wi-Fi networks is measured and displayed as a graph.

- 1** In the standby screen,  ▶ [Settings] ▶ [Wireless/Network] ▶ [Data usage]

XX MB/GB mobile data	Display mobile data usage for the time period set in [Data warning & limit] ▶ [App data usage cycle].
Mobile data	Enable/disable Internet access (packet communication) via the mobile network.
Mobile data usage	Display mobile data usage for the time period set in [Data warning & limit] ▶ [App data usage cycle] as a graph. Check mobile data usage for individual apps.
Data warning & limit	Set the time period of displayed data usage as well as an alert level and upper level on mobile data usage.
Wi-Fi data usage	Display Wi-Fi data usage for the displayed time period as a graph. Check Wi-Fi data usage for individual apps.
Network restrictions	Make settings for network restrictions.

NOTE

- If data reaches the limit and you are no longer able to use data, in the data usage screen, press [Data warning & limit] ▶ [Disable] [Set data limit] or change the upper limit in [Data limit] to resume using data. Alternatively, if "Mobile data limit reached" is displayed, select [Resume] to resume using data.
- As the displayed data usage amount is an estimation, it may be different from the actual data usage amount.
 - For customers who subscribe to a rate plan other than ahamo
Check the actual data usage amount from My docomo.
 - For customers who subscribe to ahamo
Check the actual data usage amount from the ahamo website. (in Japanese only)

Tethering

You can use the tethering function to connect Wi-Fi devices as well as PCs, etc. connected via a USB cable A to C 02 (sold separately) or Bluetooth to the Internet by using the handset as an access point.

- Connect up to 15 devices at the same time: one PC connected via a USB cable A to C 02, ten Wi-Fi devices, and four Bluetooth devices.
- Before using Bluetooth tethering, register the other Bluetooth device in advance (→P. 125). For settings on the Bluetooth device, see the instructions for the Bluetooth device.

1 In the standby screen,  [Settings] ▶ [Wireless/Network] ▶ [Tethering]

Wi-Fi hotspot	Enable Wi-Fi tethering and make settings for access point names, security, etc.
USB tethering	Enable USB tethering.
Bluetooth tethering	Enable Bluetooth tethering.

NOTE

[USB tethering]

- Tethering is available when the PC's OS is Windows 10 or Windows 11.
- A microSD card inserted in the handset cannot be mounted on a PC during USB tethering.

- For details on USB tethering, refer to the following website.
<http://www.android.com/tether#usb>

[Wi-Fi hotspot]



- While the handset is functioning as an access point, it cannot access the Internet via Wi-Fi connection.
- At the time of purchase, the access point name is set to [KY-43C] and security is set to [WPA2-Personal] while the password is set randomly. Change the settings if necessary.

VPN (Virtual Private Network)



Adding a VPN

VPN (Virtual Private Network) is a connection method to prepare and connect safely to a virtual dedicated line on the network of a household PC or in an office from outside, etc.

- Obtain required security details from your network administrator to set the VPN connection from the handset.
- Set a PIN or password for the screen lock in advance (→P. 106).

- 1 In the standby screen,  ► [Settings] ► [Wireless/Network] ► [VPN]
- 2  ► [Add profile]
- 3 Set each item ► 

Connecting a VPN

- 1 In the standby screen,  ► [Settings] ► [Wireless/Network] ► [VPN]
- 2 Select a VPN to connect to
- 3 Enter information for connecting to the VPN ► 

Disconnecting a VPN

- 1 In the standby screen,  ► [Settings] ► [Wireless/Network] ► [VPN]
- 2 Select the VPN to disconnect from ► [Disconnect]

docomo service

Make settings for docomo services.

- 1 In the standby screen,  ► [Settings] ► [docomo service]

d ACCOUNT setting	Set a d ACCOUNT for using docomo apps.
docomo location information	Make settings for imadoco search and Keitai Osagashi Service functions.
USB debug switch	Enable USB debugging.
Anshin Manager	Make settings for Anshin Manager.
Open source licenses	Show open source licenses.
i-channel display settings	Enable displaying i-channel.

NOTE

- Some apps displayed in docomo services can be disabled. Disabled apps may not be displayed in docomo services.
- Anshin Manager is a paid service requiring application.
- For details on Anshin Manager, refer to the NTT DOCOMO website.

Battery

Check battery usage, make Battery care mode settings, etc.

- 1 In the standby screen,  ► [Settings] ► [Battery]

Battery level	Check battery usage and other items.
Show battery level as percent	Enable battery level to be shown as percent in status bar.
Battery care mode	Reduce the battery level at full charge more than usual. You can reduce the load to the battery and extend battery life. Though the battery life will be extended, usage time shortens with each charge.
Battery saver	Control battery consumption when [Battery saver] is on. Select [Turn on automatically] and you can set the battery level to turn on Battery saver automatically.

Handset Information (About Phone)

You can check information about the handset.

- 1 In the standby screen,  ► [Settings] ► [About phone]

Software update	Software update →P. 150
Status	Check handset status such as battery level and phone number.
Legal information	Check legal information such as the third party license, etc.
Model	Check versions and numbers.
OS version	
Baseband version	
Kernel version	
Build number	
Compliance information	Check technical conformance certification.

More Settings

Make settings for account, date and time, etc.

- 1 In the standby screen,  ► [Settings] ► [More settings]

USB	USB →P. 116
Pointer	Enable confirmation to appear when activating the pointer, make size and speed settings, etc.
Storage	Storage →P. 116
Apps	Apps →P. 117
Location	Location →P. 117
Accounts	Manage accounts being used and make basic settings for syncing data.
Languages & input	Change between Japanese and English, and make settings for text entry. <ul style="list-style-type: none">● It may take time for changing the language.
Date & time	Date & time →P. 118
Accessibility	Accessibility→P. 119
Reset options	Reset options →P. 119

USB

You can change the settings for connecting the handset to a PC using a USB Cable A to C 02 (sold separately). Selectable when connected by USB.

- 1 In the standby screen,  ► [Settings] ► [More settings] ► [USB]

Charge this device	Use only for charging the handset.
Transfer files	This is a mode for transferring data to the handset memory or a microSD card using a PC compatible with MTP.
Transfer photos (PTP)	This is a mode for transferring still pictures to the handset memory using a PC compatible with PTP.

NOTE



- When transferring a large amount of data, transfer may be interrupted. Split the data into several files and send them separately.

Storage

Check usage of handset internal storage and a microSD card, as well as format, mount, and unmount microSD cards.

- 1 In the standby screen,  ► [Settings] ► [More settings] ► [Storage]

- 2 [Internal storage] / [SD card]

- Format a microSD card: Point the cursor to [SD card] ►  ► [Yes] ► [ERASE & FORMAT]
- Mount/unmount a microSD card: Point the cursor to [SD card] ►  ► [Yes]

NOTE

Formatting microSD cards

- All data on a microSD card will be deleted when formatted. Use caution.

Mounting/unmounting microSD cards

- Unmount a microSD card and power off the handset before inserting/removing the microSD card.

Apps

Check app information, and set app permissions.

- 1 In the standby screen,  ▶ [Settings] ▶ [More settings] ▶ [Apps]
- 2 [App info] ▶ Select the app

Disabling an app

End operation of an app and remove it from the app screen without uninstalling it.

- You can disable apps which cannot be uninstalled.

- 1 In the standby screen,  ▶ [Settings] ▶ [More settings] ▶ [Apps]
- 2 [App info] ▶ Select the app ▶ [DISABLE] ▶ [Disable app]

NOTE

- After an app is disabled, other apps linked to the disabled app may not work properly. In this instance, enable the app.

Enabling an app

- 1 In the standby screen,  ▶ [Settings] ▶ [More settings] ▶ [Apps]
- 2 [App info] ▶ Select the app ▶ [ENABLE]

Location

You can make settings for positioning to obtain location information.

- 1 In the standby screen,  ▶ [Settings] ▶ [More settings] ▶ [Location]

Location	Enable use of location. <ul style="list-style-type: none">• If confirmation is displayed, select [Agree] / [Disagree].
Mode	Change accuracy of obtaining location.
App-level permissions	Enable use of location for a selection of apps.
Scanning	Set use of Wi-Fi networks and Bluetooth devices to increase accuracy of location.
Recent location requests	Check information on apps that have recently requested location information.

NOTE

- It is necessary to enable Location to obtain current location. Some apps require that settings be made for location information by using the app.

Using the GPS function

- GPS is a function to retrieve the location information of devices by receiving radio waves from GPS satellites. It is necessary to enable Location to obtain current location.

- You cannot use the handset as a navigation system for aircraft, vehicles, persons, etc. or high-accuracy surveying GPS. DOCOMO is not responsible for any pure economic loss (damages, etc.) resulting from lost opportunities such as checking location results or communication due to malfunction, misoperation, external causes such as power stoppages (including power outages), etc. of the handset, when used for the above or any other purpose.
- GPS is a service administered by the US Department of Defense. Therefore, the condition of GPS radio waves may be controlled (accuracy degradation, radio wave stop, etc.) for US national security reasons. In addition, same results may not be obtained even when positioning is done in the same location and environment, since the condition of radio waves may change depending on the location of the GPS satellites.
- Note that GPS uses radio waves from artificial satellites, and therefore the following conditions may prevent radio waves from being received or prevent the reception of radio waves from being satisfactory, resulting in an error of 300 m or more for location information.
 - In or under a dense forest, in a high-density area with buildings or residences
 - In or under buildings
 - Inside a basement or tunnel, underground, or underwater
 - Near high-tension lines
 - Inside cars, trains, etc.
 - In bad weather with heavy rain/snow, etc.
 - Inside bags or boxes

- When people or objects are blocking the handset
- When hands are covering the GPS antenna area
- When using the GPS function overseas, information based on the acquired location (latitude and longitude information) may not be accurate because of the legal system, etc. in each country and the area.
- GPS assist data such as satellite information may be automatically retrieved when you obtain current location.

Date and Time

You can make settings for the date and time and their format.

- 1 In the standby screen,  [Settings] ▶
[More settings] ▶ [Date & time]

Automatic date & time	Enable use of time information provided from the network.
Automatic time zone	Enable use of time zone information provided from the network.
Set date	Set the date manually.
Set time	Set the time manually.
Select time zone	Set the time zone manually.
Use 24-hour format	Switch between 12-hour and 24-hour formats.

NOTE

When [Automatic date & time] is enabled

- If the handset does not adjust the time for a while after being powered on, turn power off the handset and restart it.
- Time may not be adjusted depending on signal conditions.
- The clock may gain or lose a few seconds.

Accessibility

You can make settings for accessibility options.

- 1 In the standby screen,  ► [Settings] ► [More settings] ► [Accessibility]

Color inversion	Set screen colors to be displayed inverted.
Color correction	Enable color correction or set the correction mode.
Captions	Make settings for captions.
High contrast text	Set a higher contrast for onscreen text.

Reset options

Erase all data in handset memory.

- 1 In the standby screen,  ► [Settings] ► [More settings] ► [Reset options]
- 2 [Erase all data (factory reset)] ► [RESET PHONE] ► [ERASE EVERYTHING]
 - Reset all network settings: [Reset Wi-Fi, mobile & Bluetooth] ► [RESET SETTINGS] ► [RESET SETTINGS] ► [OK]
 - Reset all restrictions, etc. for disabled apps and permissions: [Reset app preferences] ► [Yes]

NOTE

- The following data are erased.
 - Data that were created, saved, or registered
 - Settings made in the Settings menu

Quick settings

Use Quick settings to enable/disable functions such as Airplane mode, Wi-Fi, etc. quickly.

Example: Turning ON/OFF Airplane mode

- 1 In the standby screen,  (at least 1 second)**
 - Quick settings screen is displayed.
- 2 Checkmark [Airplane mode] to turn on Airplane mode**
 - Uncheck to turn off.

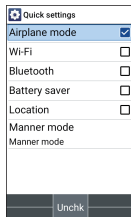

Data Management

Handset memory (internal storage)

The folder structure of handset memory (/storage/emulated/0) and data saved in the folders at time of purchase are as follows.

Alarms	Alarm tones, etc. are saved.
DCIM	Temporary files etc. of installed apps are saved.
Download	Files downloaded on web browser are saved.
Movies	Videos, etc. are saved.
Music	Music data, etc. is saved.
Notifications	Notification sounds, etc. are saved.
Pictures	Still pictures, etc. are saved.
Podcasts	Music data, etc. transferred from podcasts is saved.
Ringtones	Ringtones, etc. are saved.

microSD card (external storage)

You can save data on the handset to a microSD card or import data on a microSD card to the handset.

- microSD card →P. 45

Working with files

You can categorize data that is saved in handset memory or on microSD card and play/view and manage it.

- 1 In the standby screen,  [Data]
- 2 Select a category

Pictures	Display images.
Movies	Display movies.
Music	Display music, etc.
Documents	Display Microsoft Word / Excel / PowerPoint documents created on a PC as well as PDF data and text data.
PIM	Display phonebook and schedule data.
File manager	Display folders in handset memory and on microSD card.

3 Select data

- App corresponding to the data type activates to play/display the data.
- For data saved on microSD card, **SD** is displayed.

NOTE

- Some data in Data Folder may not be displayed or played.
- It may take time for data to be displayed or not all data may be displayed depending on data size.

Data management

Data submenu operations

- Menu items may vary by usage function or condition of use.

1 In the data list,

Set as	Register a still picture to the phonebook entry or as wallpaper.
Set as ringtone	Set a ringtone.
Send	Send data as an attachment or by Bluetooth transfer.
Delete	Delete one item or select and delete items.
Rename	Change a file name.
View mode	View mode →P. 122

Details	Display detailed information of selected data.
Copy	Copy →P. 122
Move	Move →P. 122

NOTE

[Set as]

- Copyrighted data may not be used as registered data.

Changing data views

1 In the data list, [View mode]



View mode	Change view modes (All / Years view / Folder view).
Layout	Change layout (Grid / List (Simple) / List).

Copying/moving data

Copy or move saved data from handset memory to microSD card, or from microSD card to handset memory.



1 In the data list, point the cursor to the data to copy/move [Copy] / [Move]

2 [Copy one] / [Move one] [OK]

- Copy/move selected: [Copy multiple] / [Move multiple]  [Internal storage to SD] / [SD to internal storage]   [OK]

Managing data with the file manager

- Menu items may vary by usage function or condition of use.

1 In the standby screen,  ► [Data] ► [File manager] ► 

Set as	Register a still picture to the phonebook entry or as wallpaper.
Set as ringtone	Set a ringtone.
Send	Send data as an attachment or by Bluetooth transfer.
Copy	Copy folders/data.
Move	Move folder data.
Paste	Paste copied folder/moved data.
Delete	Delete one folder/data item or select and delete.
Search	Search folders/data.
Sort	Sort folders/data.
Rename	Change a folder/data item name.
Add folder	Add a folder.
View mode	Change layout (Grid / List (Simple) / List).
Details	Display detailed information of a folder/data.
Add shortcut	Add a folder shortcut to Data Folder.

PC connection

You can use the handset memory or microSD card as external memory for a PC or transfer data by connecting the handset and the PC.

Connecting the handset and PC

- 1 Insert the Type-C plug on the USB cable A to C 02 (sold separately) into the external connector terminal on the handset without bending
- 2 Insert the USB plug on the USB cable A to C 02 into the USB connector on the PC without bending
 - USB connection mode →P. 116
 - Tethering settings →P. 112

NOTE

- Use a USB cable compatible with the handset. A plug with a different shape cannot be used.
- Using a USB hub or adapter plug may prevent normal use.
- Do not remove the USB Cable A to C 02 while exchanging data with the PC. Data may be damaged.
- Connectable PC operating systems are Windows 10 and Windows 11 (Japanese versions).

Transferring data

You can transfer data from a PC to handset memory or microSD card.

- 1 Connect the handset to a PC via a USB Cable A to C 02 (sold separately)
- 2 [OK]
- 3 Transfer data
- 4 Disconnect the Cable A to C 02 from the handset and the PC after use

Data Transfer

Bluetooth® transfer

The Bluetooth function is a technology that enables wireless connection with Bluetooth devices such as PCs and handsfree headsets.

- Wireless connection with all Bluetooth devices is not completely guaranteed.
- Supported Bluetooth profiles →P. 152



NOTE

- The Bluetooth on/off setting does not change with handset powered off.
 - You can turn OFF the Bluetooth function to reduce battery consumption.
- **Radio interference with Wi-Fi-compatible devices**
- Bluetooth devices and wireless LAN (IEEE 802.11 b/g/n) use the same frequency band (2.4 GHz). Using the handset near a wireless LAN device may cause interference, resulting in lower communication speed, noise, and poor connection. In this instance, turn off the wireless LAN device or keep the handset and the connected Bluetooth device at least 10 m away from the wireless LAN.

Using the Bluetooth function

Before connecting the handset and the Bluetooth device, pair them first.

- Once paired, pairing information is saved.
- A passcode (PIN) may be required to pair the devices. The handset's passcode (PIN) is "0000". If pairing cannot be completed after entering "0000", see the instructions for the Bluetooth device.
- Check on the device to be paired that the Bluetooth function is on and that it is discoverable beforehand.

- 1 In the standby screen,  [Settings] ▶ [Wireless/Network] ▶ [Bluetooth]
- 2 Checkmark [Bluetooth settings] to enable it
- 3 [Pair new device] ▶ Select the Bluetooth device ▶ [Pair]
 - Confirmation for connection may be displayed.
 - Entering the Bluetooth pairing code (passcode) for the other Bluetooth device may be necessary. Also, some Bluetooth devices may start connection after being registered.
 - Change the name and purpose of the other Bluetooth device: [Paired devices] ▶ Point the cursor to the already-paired Bluetooth device ▶ 



NOTE

- You can connect up to 7 Bluetooth devices at the same time. Bluetooth devices may not work properly or the number of Bluetooth devices which can be connected at the same time may differ depending on the profile.
- If connecting a Bluetooth device fails, connection may be possible after re-registering it.
- When [Bluetooth settings] is set to ON and the screen "Pair new device" is displayed, the handset is discoverable and can receive registration requests/connection requests from other Bluetooth devices.
- While in connection stand-by, even if a connection request from a Bluetooth device is received, connection may not be made depending on the signal conditions, etc.
- For details on operating the other Bluetooth device, refer to the manual of the Bluetooth device to be used.

When receiving a registration request from a Bluetooth device or a connection request from an unregistered Bluetooth device

- 1 Registration request/connection request from Bluetooth device
- 2 [Pair]
 - Entering the Bluetooth passkey may be necessary depending on the other Bluetooth device.
 - Confirmation for connection may be displayed.



Unregistering Bluetooth devices

- 1 In the standby screen,  [Settings] ▶ [Wireless/Network] ▶ [Bluetooth] ▶ [Paired devices]
- 2 Point the cursor to the Bluetooth device to unregister ▶  [Forget]

Disconnecting Bluetooth devices

- 1 In the standby screen,  [Settings] ▶ [Wireless/Network] ▶ [Bluetooth] ▶ [Paired devices]
- 2 Select the Bluetooth to disconnect ▶ [OK]

Submenu operations on the Bluetooth screen



- Set [Bluetooth settings] to ON beforehand.
- 1 In the standby screen,  [Settings] ▶ [Wireless/Network] ▶ [Bluetooth] ▶ 

Rename the device	Change handset name.
Received files	Display data received via Bluetooth transfer.

Sending/receiving via Bluetooth transfer

Sending data

Example: Still picture

- 1 In the standby screen,  ► [Data]
- 2 [Pictures] / [File manager] ► Select a still picture
- 3  ► [Send] ► [Send one] ► [Bluetooth]
 - Send selected: [Send multiple] ► Select the still pictures to send ► 
 - Set the receiver's Bluetooth device to reception stand-by.
- 4 Select a Bluetooth device to connect to

Receiving data

- 1 Data is sent from a sending Bluetooth device
- 2 [Accept]
- 3 In the standby screen,  ► Select the status bar ► Select the receive notification ► Select the received data

NOTE

- It may not be possible to receive all data depending on the data type.

- If space where data is being saved becomes insufficient while receiving data, data received to that point is saved and receiving ends.

Disaster message board

Disaster Message Board is a service which enables you to register or check the safety of you and others in case of a large-scale disaster such as a "6-lower" or stronger earthquake.

Type in and register information on your safety from the handset. The information can be checked from your family's mobile phones, PCs, etc.

For details on Disaster Message Board, refer to the NTT DOCOMO website.

1 In the standby screen,  ► [Anshin] ► [Disaster Message Board]

- Continue by following the instructions on the screen.

Early warning "Area Mail"

This service enables you to receive Earthquake Early Warnings, Tsunami Warnings, special alerts from the Meteorological Agency, and Disaster and Evacuation Information from national or local authorities, regardless of busy network conditions.

- Area Mail is a free service that does not require a subscription.
- You can save up to 50 Area Mails. If the number of Area Mails saved in handset memory exceeds the maximum number that can be saved, they are deleted starting with the oldest one.
- Area Mail cannot be received in these situations.
 - While powered off
 - During international roaming
 - While in airplane mode
 - During a software update
 - While the entry screen for the PIN code is displayed
 - When using a non-docomo SIM card
 - During voice calls (except for voice calls with VoLTE)
- You might not be able to receive Area Mail if free memory space is insufficient, or if tethering is set or you are using packet communication.
- Area Mail you were unable to receive (Earthquake Early Warnings) cannot be received again. Other Area Mail (Tsunami Warnings, special alerts from the Meteorological Agency, and Disaster and Evacuation Information) is sent again, and can be received again if you could not receive it the first time.

Receiving early warning "Area Mail"

After Area Mail is received, a notification is displayed, and the handset emits an alert buzzer sound or ringtone and vibrates.

- The buzzer sound or ringtone cannot be changed.

- 1 Automatically receive an Area Mail
- 2 When the Area Mail is received, the handset alerts you (buzzer or ringtone), an icon appears in the status bar, and the Area Mail message appears

Checking received Area Mail later

- 1 In the standby screen,  ► [Anshin] ► [Early warning "Area Mail"]
- 2 Select the received Area Mail

Deleting Area Mail

- 1 In the standby screen,  ► [Anshin] ► [Early warning "Area Mail"]
- 2 Point the cursor to an Area Mail
- 3 [Delete] ► [Delete]

Setting early warning "Area Mail"

You can set whether to receive Area Mail, operation when received, etc.

- 1 In the standby screen,  ► [Anshin] ► [Early warning "Area Mail"]
- 2  ► [Settings]

Receive setting	Set whether to receive Area Mail.
Emergency alert history	Show a list of received Area Mail.
Vibration	Set the handset to vibrate when Area Mail is received.
Alert reminder sound	Set whether the handset notifies you again for received Area Mail. The handset emits an alert (buzzer or ringtone) and vibrates. If set to once, the handset renotifies you one time, 2 minutes after the Area Mail is received. If set to every 2 minutes, the handset renotifies you up to 3 times every 2 minutes, starting 2 minutes after the Area Mail is received. If set to every 15 minutes, the handset renotifies you up to 3 times every 15 minutes, starting 15 minutes after the Area Mail is received.

Use full volume	Set the volume when Area Mail is received. When enabled, the alert sounds at maximum volume even if in Manner mode. When disabled, the alert sounds according to the set alarm volume.
Check screen image and beep tone	Check the receiving screen and sound (buzzer/ringtone) when Area Mail is received (Earthquake Early Warning, Tsunami Warning, Disaster and Evacuation Information/special alerts from the Meteorological Agency).
やさしい日本語表示 (Easy Japanese)	Enable Earthquake Early Warnings and Tsunami Warnings to be displayed in easy-to-understand Japanese.

Anshin Security

Anshin Scan

A warning screen appears to alert you when connecting to sites where the handset is at risk of phishing or virus infection, or Wi-Fi hotspots where there is a risk of transmitted data being altered or viewed.

- In the standby screen,  ► [Anshin] ► [Anshin Security] ► [Anshin Scan]
 - Continue by following the instructions on the screen.

NOTE

- docomo Anshin Scan is a paid service requiring subscription to Anshin Security.

Anshin Number Check

Receive notification in advance of arriving nuisance sales calls or suspicious scam calls.



- In the standby screen,  ► [Anshin] ► [Anshin Security] ► [Anshin Number Check]
 - Continue by following the instructions on the screen.

NOTE

- Anshin Number Check is a paid service requiring subscription to Anshin Security.

Anshin Filter

This browser application allows parents/guardians to restrict apps and access to harmful sites according to a child's age and how they use the handset for worry-free handset operation.

- 1 In the standby screen,  ► [Anshin] ► [Anshin Filter]
 - When the confirmation screen is displayed, check the content and press .
 - If initial settings are not completed, the initial settings screen appears. Follow the instructions on the screen.

NOTE

- For details on Anshin Filter for docomo, refer to the NTT DOCOMO website.
- While using Anshin Filter for docomo, the handset's standard browser cannot be used.

Overseas use

Outline of international roaming (WORLD WING)

With the international roaming (WORLD WING), you can use the handset without changing phone number or mail address in the service area of the overseas network operator affiliated with DOCOMO. You can use Phone and SMS without changing settings.

- For details on the international roaming (WORLD WING), refer to the NTT DOCOMO website.
<https://www.docomo.ne.jp/english/service/world/roaming/>

■ Available networks

You can use the handset within the service area of LTE network, 3G network and GSM/GPRS network. Also, you can use the handset in countries/regions where 3G850MHz/GSM850MHz is supported.

NOTE

- For the country codes/international call access number/Universal number international prefix/compatible countries and regions and overseas network operators, refer to the NTT DOCOMO website.

Available services for overseas

Main communication services	LTE	3G	3G850	GSM (GPRS)
Phone	○	○	○	○
SMS	○	○	○	○
Packet communication*	○	○	○	○

- * To use packet communication during roaming, set Data roaming setting to "ON" (→P.133).
- Some services may not be available depending on the network operator or network overseas.

Before using the handset overseas

Before leaving Japan

To use the handset overseas, check the following in Japan before departure.

■ Subscription

- Check if you subscribe to WORLD WING. For details, contact the contacts on the back cover.
If you subscribe to ahamo, you need not apply for WORLD WING and cannot cancel it.

■ Charging

- For details on charging, refer to the NTT DOCOMO website.

■ Usage charge

- Overseas usage charges (call and packet communication) differ from those in Japan. For details, refer to the NTT DOCOMO website. If you subscribe to ahamo, be sure to confirm the details on the ahamo website. (in Japanese only)

- Since some applications automatically perform communications, packet communication charges may become high. For operation of applications, contact the application providers.

Advance preparation

■ About setting network service

If you subscribe to network services, you can use network services such as Voice Mail Service, Call Forwarding Service, Caller ID request service, etc., even overseas. Some network services are not available.

- To use network services overseas, you need to set "Remote operation" to activate. You can set "Remote operation" in the country you visit.
From Japan (→P.69), from overseas (→P.137)
- Even if the setting/canceling operation is available, some network services cannot be used depending on overseas network operators.

After arriving overseas

When you arrive overseas and turn the handset ON, a connection to the available network operator/network is established automatically.

■ Connectivity

If "Select automatically" in "Mobile network" is set to ON, the handset selects the most suitable network automatically.

Settings for overseas use

■ Setting Data roaming

To perform packet communications overseas, set Data roaming settings to "ON".

- 1 In the standby screen,  ► [Settings] ► [Wireless/Network] ► [Mobile network]
- 2 [Data roaming] ► [ON] ► Check the contents on the Attention screen, [OK]

■ Setting Network operators

At time of purchase, the handset is set to automatically search and switch to an available network. To switch network manually, perform the following operations.

- 1 In the standby screen,  ► [Settings] ► [Wireless/Network] ► [Mobile network] ► [Select automatically] ► [OFF]
 - Available networks are searched for and displayed.
 - When an error occurs in network search, set [Mobile data] to [OFF] and then retry (→P.110).

2 Select a network of the network operator

NOTE

- To switch network automatically, set [Select automatically] to [ON].

■ Setting the preferred network type

- 1 In the standby screen,  ► [Settings] ► [Wireless/Network] ► [Mobile network] ► [Preferred network mode]
- 2 [4G/3G/GSM(Auto)] / [3G/GSM] / [GSM]

■ Date & time

When [Automatic date & time]/[Automatic time zone] in [Date & time] is set to ON, the date, time and time differences of the handset are corrected by receiving information related to time and time differences from the network of overseas telecommunications carrier you connect to.

- Correction of the time or time differences may not be performed correctly depending on the network of overseas network operator. In that case, set time zone manually.
- Timing of correction varies by the overseas network operator.
- "Date & time" (→P.118)

■ About inquiries

- For loss or theft of the handset or nano SIM card, immediately contact DOCOMO from the spot to take the necessary steps for suspending the use. For inquiries, see the back cover of this manual. Also, you can take the steps for suspending the use from My docomo. Note that you are still liable for the call and communication charge incurred after the loss or theft occurred.
- For using from land-line phone, entering "International call access number" or "Universal number international prefix" for the country is needed.
- If you subscribe to ahamo, contact us from the ahamo website. (in Japanese only)

Making/Receiving a call in the country you stay

Making a call to outside country you stay (including Japan)

By utilizing an international roaming service, you can make a call to the other party's land-line phone or mobile phone in other countries/regions in the same way you do in Japan.

- To easily make an international call to Japan or other countries/regions from the country you stay, add "+" before Country code and phone number.
- For available countries and network operators, refer to the NTT DOCOMO website.

- 1 In the standby screen,  (at least 1 second) ► Enter the country code, region code (area code), and then phone number
 - As for region codes (area codes) that begin with "0", omit the first "0" when entering. Some countries, such as Italy, may require a first "0".
 - To call an overseas WORLD WING user, enter "81" (Japan) for the country code.



- 3 To end a call, 

Making a call using International dial assist

To make a call to other countries/regions from the country you stay, use International dial assist for making an international call in simple operation.

- Set [Automatic conversion] in international dial assistance to ON in advance (→P.137).
- The first "0" of the region code is converted to the country code specified in advance.

1 In the standby screen, 

2 Enter the region code (area code), and then phone number

3 

- When the "International dial assist" screen is displayed, select [Convert number].

4 To end a call, 

Making a call inside the country you stay

You can make a call to the other party's land-line phone or mobile phone just by entering the phone number in the same way you do in Japan.

1 In the standby screen, 

2 Enter a phone number

- To make a call to a land-line phone, enter the region code (area code), and then phone number.

3 

- When the "International dial assist" screen is displayed, select [Use original number].

4 To end a call, 

Making a call to overseas WORLD WING users

If you make a call to the party using international roaming, make a call as an international call to Japan even when making a call in the country you stay.

- As this communication is made via Japan regardless of the country you stay, enter the phone number as you make an international call to Japan.

In the standby screen,  (at least 1 second) ▶ 81 (Country code for Japan) ▶ Phone number with leading "0" omitted

Receiving a call inside the country you stay

You can receive a call when you are overseas in the same way as you do in Japan.

NOTE

- An incoming call during international roaming is forwarded internationally from Japan regardless of which country/region the call is from. A caller is charged for a communication fee to Japan, and the receiver is charged for a reception fee.

Making a call to your handset

■ To have the other party in Japan call you overseas

To have the other party in Japan call you using a land-line phone or mobile phone, the other party can call you just by dialing your phone number in the same way as the other party does in Japan.

■ To have the other party outside Japan call you overseas

You have to receive a call through Japan no matter where you are; therefore, the other party needs to enter the international call access number of the country of the caller and "81" (Country code for Japan). International call access number of the country of the caller-81-90 (or 80, 70) - XXXX - XXXX

Setting international roaming

Make settings to use the international roaming service.

- The settings may not be made depending on overseas network operator.

1 In the standby screen,  ► [Phone] ► [Call log/Call settings] ► [Roaming settings]

Bar incoming on roam	Restrict incoming calls during international roaming.
Missed call notice on roam	Notify you of missed calls when you are out of service area, etc. during international roaming via SMS.
Roaming guidance	Notify a caller of international roaming with a guidance indicating it is a call during international roaming.
Int'l dial assistance	P.137
Network service	P.137

Setting International dial assist

- 1 In the standby screen, **[MENU]** ▶ **[Phone]** ▶ **[Call log/Call settings]** ▶ **[Roaming settings]** ▶ **[Int'l dial assistance]**

Automatic conversion	Add a country code automatically.
Country code	Select a country code used for Automatic conversion.
International prefix	Register international prefixes used for international calls.

Setting the network service (overseas)

Set the network services such as the voicemail service to use overseas.

- Activate "Remote operation" in advance (→P.69).
- If you make the settings overseas, you are charged a call fee to Japan from the country you stay.
- The settings may not be made depending on overseas network operator.

- 1 In the standby screen, **[MENU]** ▶ **[Phone]** ▶ **[Call log/Call settings]** ▶ **[Roaming settings]** ▶ **[Network service]**

Remote operation (paid)	Enable the remote operation.
-------------------------	------------------------------

Caller ID request (paid)	Plays the guidance of requesting a caller ID notification when receiving a call with an unknown number.
Missed call notice (paid)	P.136
Roaming guidance (paid)	P.136
Voicemail (paid)	Takes a message from a caller while you are outside of the service area or when the handset is turned off. (Subscription is required)
Call forwarding (paid)	Forwards a call to another mobile phone, etc. registered in advance. (Subscription is required)

- 2 Operate following the onscreen instructions
- 3 Operate following the voice guidance

After returning to Japan

After returning to Japan, restore to the settings which are made before you traveled.

■ When you used packet communication overseas

Set [Data roaming] (→P.133) to [OFF].

■ When you cannot connect DOCOMO network automatically after returning to Japan

- Set [Preferred network mode] (→P.134) to [4G/3G/GSM(Auto)].
- Set [Select automatically] in [Mobile network] to [ON] (→P.133).

Appendix/Index

Handset menus

- When numbers appear next to menu items, press the dial key of the same number to select the item.

Mail

Function menu	Page
Mail	P.75
+Message(SMS)	P.78
PC Mail	P.82

Web

Function menu	Page
Homepage	P.88
My docomo	P.170
Bookmarks	P.87
Web Search	P.87
History	P.88
Downloads	P.89
Phone Guide	—
Web Settings	P.88

Anshin

Function menu	Page
Disaster Message Board	P.128
Early warning "Area Mail"	P.128
Anshin Security	P.130
Anshin Filter	P.131

Notepad

- Notepad →P.94

Data

- Data →P.121

Calculator

- Calculator →P.91

Phone

Function menu	Page
Phonebook	P.71
docomo voicemail	—
Call/Ans Memo	P.67
Redial	P.66
Received Calls	P.66

Function menu		Page
Call log/Call settings	Network service	P.68
	Roaming settings	P.136
	Incoming call settings	P.69
	Outgoing call settings	P.70
	Other settings	P.70
Speed dial settings		P.61

Settings

Function menu		Page
Wallpaper/Display	Wallpaper	P.101
	Brightness level	P.102
	Backlight time	P.101
	Key backlight	P.101
	Font size	P.101
	Sub display	P.38
	Visibility adjustment	P.101

Function menu		Page
Sound/Notification	Volume	P.103
	Manner mode	P.103
	Media sound in Manner mode	P.102
	Manner key long press action	P.102
	Phone ringtone	P.102
	Also vibrate for calls	P.102
	Vibration pattern	P.102
	Incoming LED	P.102
	Notification sound	P.102
	Pulse notification light	P.102
Other sounds	P.102	

Function menu		Page
Lock/Security	Operation password setting	P.105
	Lock screen	P.106
	Application lock	P.106
	Usage restriction	P.106
	Show passwords	P.104
	Device admin apps	P.104
	SIM card lock	P.107
	Encryption & credentials	P.107
	Trust agents	P.104
	Screen pinning	P.104
	Apps with usage access	P.104
Wireless/ Network	Wi-Fi	P.108
	Bluetooth	P.125
	Airplane mode	P.108
	Mobile network	P.110
	Data usage	P.111
	Restrict data	P.108
	Tethering	P.112
	VPN	P.113

Function menu		Page
docomo service	d ACCOUNT setting	P.114
	docomo location information	P.114
	USB debug switch	P.114
	Anshin Manager	P.114
	Open source licenses	P.114
	i-channel display settings	P.114
Battery	Battery level	P.114
	Show battery level as percent	P.114
	Battery care mode	P.114
	Battery saver	P.114
Custom key		P.59
About phone		P.115
More settings	USB	P.116
	Pointer	P.34
	Storage	P.116
	Apps	P.117
	Location	P.117
	Accounts	P.115
	Languages & input	P.115
	Date & time	P.118
	Accessibility	P.119
	Reset options	P.119

Tools

Function menu	Page
Alarm	P.91
Countdown Timer	P.93
Stopwatch	P.93
World clock	P.93
Weather	P.95
Kanji Check	P.96
OfficeSuite	P.96
Instruction Manual	H2
SD card backup	P.96
Data Security	P.98
Data Switch	P.98

Calendar

- Calendar →P.90

Profile

- Profile →P.39

Sound Recorder



- Sound Recorder →P.94

Troubleshooting (FAQ)

Check here first

- You can perform a diagnosis yourself if you think the handset may be malfunctioning.
For details, see the NTT DOCOMO website.
- Check if the software needs to be updated, and update it if necessary (→P.150).
- If problematic symptoms are not improved after going through the check items, feel free to contact us. For inquiries, see the back cover of this manual.

Power

- Handset does not power on
 - Is the battery pack installed correctly? →P.47
 - Is the battery depleted? →P.48
- Screen does not respond, cannot power handset off
 - You can press  and  at the same time for at least 11 seconds to force-shut down the handset and restart it.
 - * Note that the handset is being forced to restart, and data, settings, etc. may be lost.

Charging

- Cannot charge

The charging lamp does not illuminate or it flashes

- Is the battery pack installed correctly? →P.47
- Is the power plug on the adapter firmly connected to an outlet or accessory socket? →P.49
- Are the adapter and the handset connected properly? →P.49
- If using an AC adapter (sold separately), is the connector on the AC adapter connected firmly to the handset or the desktop holder (sold separately)? →P.49, P.50
- If using a USB cable A to C 02 (sold separately), is the computer turned on? →P.123
- If a call, data communication, or other function is performed for a long time while charging, the handset may become warm and charging may stop. In this instance, let the handset cool down and charge it again. →P.48

Handset operation



- Becomes hot while operating/charging

- The handset, battery pack, or the adapter may become warm during use, charging, or if using apps, etc. for a long period while charging, but this is normal. Continue use. →P.48

- Usable battery time is short
 - Is the handset outside of the service area and not used for long periods? When out of the service area, the handset searches for a signal to enable communication, and uses up more power.
 - Battery pack usable time depends on environment of usage and battery pack deterioration. →P.152
 - The battery pack is consumable. Available time shortens with each repeated charge. If usable time becomes extremely shorter than at the time of purchase even after fully charged, purchase a new specified battery pack. →P.48
- Unintended handset power off or restart occurs
 - A soiled terminal on the battery pack may cause a bad connection and the handset to power off. If soiled, clean the terminal on the battery pack with a dry cotton swab.
- No response by pressing keys
 - Make sure the handset is not powered off. →P.52
- Screen response is slow when pressing keys
 - This can happen such as when a large amount of data is saved on the handset, or when exchanging a large amount of data between the handset and a microSD card. →P.116
- nano SIM card is not recognized
 - Is the nano SIM card inserted facing the right direction? →P.41

- Clock is incorrect
 - The clock time may become inaccurate if the handset is powered on for a long period. Make sure [Automatic date & time] in [Date & time] is enabled and power the handset on again in a location with good signal conditions. →P.118
- Handset operation is unstable
 - An application installed after purchasing the handset may be the cause. If the symptom improves after starting the handset in safe mode, uninstalling an app you installed can improve the symptom.
 - * Safe mode is a function whereby the handset is started in a mode close to that when purchased.
 - How to activate safe mode





Power on the handset when power off, then keep pressing  on the screen during activation until the standby screen is displayed.

 - * Alternatively,  (for at least 1 second) while the handset is powered on ▶Point the cursor to [Yes] ▶ (for at least 1 second) ▶[Yes] to activate safe mode.
 - * After safe mode activates, "Safe mode" appears at the lower screen left.
 - * To exit safe mode, power the handset on again.
 - Be sure to back up important data before using safe mode.
 - Since the handset is not started normally while in safe mode, be sure to exit safe mode to use the handset normally.

- App does not work properly (does not activate, error frequent, etc.)
 - Are there any disabled apps? Enable a disabled app and try again. →P.117

Calling

- Calls cannot be made by pressing key
 - Is the handset in Airplane mode? →P.108
- Ringtone does not sound
 - Is the volume for ringtone / mail / notifications at [0 (Manner mode)]? →P.102
 - Is the handset in Public mode (power OFF), Manner, or Airplane mode? →P.68, P.103, P.109
 - Is a set ring start time or reject call setting set? →P.69, P.70
 - Is the ringing time for voicemail service or call forwarding service set to "0sec"? →P.68

- Calls cannot be made ([, ] does not disappear even after moving to another place or calls cannot be made/received even though signal status is not bad)
 - Power on the handset again or install the battery pack or nano SIM card again. →P.41, P.47, P.52
 - Depending on the signal type, even if "inside the service area" or "[, ] (indicating signal status) appears" are displayed, making/receiving a call may not be possible. Move to another place and call again.
 - Make sure a call restriction such as reject call setting is not set. →P.70
 - In a crowded place, heavy telephone/mail traffic may make it difficult to get a connection depending on how congested signal conditions are. Move to another place or call again later.

Screen

- Display is dark
 - Is the screen timeout set to a short duration? →P.101
 - Have you changed the brightness level? →P.102





Sound

- The other party's voice is not heard well or is too loud during a call
 - Have you changed the in-call volume? →P.102

Mail

- Mail is not automatically received
 - Is the auto reception setting set to [Confirm every time] or [OFF]? →P.77

Overseas use

- Cannot use the handset
 - If [, ] is displayed
 - Do you subscribe to WORLD WING? Check if you subscribe to WORLD WING.
 - If [, ] (Out of service area) is displayed
 - Are you at a location that is outside of the international roaming service area, or where the signal is weak? See the NTT DOCOMO website to check if it is the available service area or the available overseas network operator.
 - Set [Preferred network mode] to [4G/3G/GSM(Auto)]. →P.134
 - Set [Select automatically] for the network operator to [ON]. →P.133
 - It may be recovered by turning the handset OFF and ON.
- Cannot perform data communication overseas
 - Set [Data roaming] to [ON]. →P.133
- Cannot use the handset suddenly while using overseas
 - Check if usage amount exceeds the limit of maximum charges for use. For use of "International roaming service (WORLD WING)", the limit of maximum charges for use is set in advance. If exceeding the limit of maximum charges for use is exceeded, pay the charges.
- No caller ID is notified/A notified caller ID is different from that of the caller/Functions for using contents saved in the phonebook or those using Caller ID notification do not operate

- Even when a caller notifies its caller ID, it is not displayed on the handset unless notified from the network or the network operator in use. And, a notified caller ID may be different from that of the caller by some networks or network operators you use.

Data Management

- Cannot use data transfer
 - Are you using a USB hub? Using a USB hub may prevent normal use. →P.123
- Data saved to microSD card does not appear
 - Reinstall the microSD card. →P.45
- A "X" is displayed when an image is opened
 - This is displayed when the image data is damaged.

Bluetooth function

- Cannot connect to Bluetooth device/cannot find after searching
 - You must first set the Bluetooth device (commercially available) so it is waiting to be paired, and then register the device on the handset. To delete a registered device and re-register it, first deregister devices on both the Bluetooth device (commercially available) and the handset, and register them again. →P.125
- Calls cannot be made from the handset with an external device such as a car navigation system or hands-free device connected
 - Making a call to a phone number may not be possible

if you make multiple calls to the phone number when the other party does not answer or is outside the service area. In this instance, power off the handset and power it on again. →P.52

Error messages

- [Running out of storage]
 - Handset storage is full. Move or delete app data.
- [Enter PIN] / [Enter Password]
 - Appears when an operation was attempted while the handset lock is set. Enter the PIN or password to temporarily disable the handset lock and continue operation.
- [Cellular network not available] / [Unable to dial]
 - Check that a preferred network type that is valid is set. →P.110

Warranty & after-sales service

Warranty

- Warranty is for 1 year from date of purchase.
- Battery Pack KY01 and Back Cover KY03 are not covered by the warranty.
- Note that the specifications and appearance of the handset, including accessories, may change without notice.
- Information registered in the phonebook, etc. may become altered or erased through malfunction, repair, or other handling of the handset. It is recommended that backup be kept of information such as phonebook.
- * You can use the handset to save phonebook and other data to a microSD card.
- * You can back up data such as phonebook, etc. by using docomo cloud.
- * Some applications or services are not available depending on your contract detail. For details, refer to the NTT DOCOMO website.

Free repair service provisions

1. In case the handset has a malfunction under normal-use conditions in line with the directions given in the instruction manual etc., it will be repaired free of charge on the condition that the warranty period has not expired. (In some cases, the handset may be replaced with the substitute.)

2. Even if the warranty period has not expired, a fee may be charged for repair under the following circumstances.
 - (1)The malfunction or damage is due to modification (including alteration of software) of the handset.
 - (2)The malfunction or damage is due to damage of the handset body, display, external connection jack, etc. caused by being dropped or subjected to an external pressure, or the malfunction or damage is due to breakdown or deformation of the internal circuit board of the handset.
 - (3)The malfunction or damage is due to fire, pollution, abnormal voltage, earthquake, thunder, wind and flood damage or other natural disaster, etc.
 - (4)The malfunction or damage is due to connected devices other than specified or consumable items.
 - (5)The malfunction or damage is due to water infiltration, wetting is detected by wetting detectable sticker of the handset, signs of submergence or water stain is found, or corrosion by condensation is found.
 - (6)The product has been repaired by other than a repair office specified by DOCOMO.
3. This warranty is valid only in Japan.
4. This warranty guarantees repair free of charge during the period and under the conditions specified on this warranty card. Thus this warranty does not limit the legal rights of the owner.

5. If several malfunctions are detected on the handset, all of malfunctions will be repaired because the quality of the product cannot be guaranteed by a partial repair. In that case, repair may be out of the warranty of free charge repair.
6. The software of the handset may be updated to the latest one when operation confirmation test is performed without regard to repair.
7. Please find repaired part and repair date on the repair report that is handed over upon completion of repair.

<Sales>

NTT DOCOMO, INC.

11-1, Nagata-cho 2-chome, Chiyoda-ku, Tokyo

After-sales service

If you have problems with your handset

Before asking repair, see "Troubleshooting" in this manual to check the problem.

If a repair is required

We will take repairs at the DOCOMO-specified repair office (our repair office or NTT DOCOMO website). For inquiries, see the back cover of this manual.

Note that repairs may require several days depending on the malfunction/breakage.

■ If the warranty period has expired

The handset can be repaired at cost upon request.

■ Period that parts are stocked

Repair parts (for maintaining handset performance) are usually stocked for at least 4 years after end of production.

For details on servicing when requesting repairs, see the NTT DOCOMO website.

However, repairs might not be possible depending on the location of malfunction/breakage if repair parts are not in stock. For details, contact a docomo-designated repair office. For inquiries, see the back cover of this manual.

IMPORTANT!

- Do not modify the handset or accessories.
 - May cause fire, injuries, or malfunction.
 - A handset that has been modified can be accepted for repairs only after receiving the customer's acknowledgment that modified components will be returned to as they were. However, the handset may be refused for repairs depending on how it has been modified.

The following instances may be deemed to be modifications.

 - Stickers, etc. placed over the display or keys
 - Ornamentation adhered to the handset with glue, etc.
 - Replacing the exterior or other component with a non-docomo-brand item, etc.
 - Malfunction or damage due to modification will be subject to repairs at cost even if within the warranty period.
- Do not peel off the nameplate sticker attached to the handset.

If the nameplate sticker is peeled off intentionally or another nameplate sticker is attached, note that the handset may be refused for repairs.
- Information such as function settings may be cleared (reset) through malfunction, repair, or other handling of the handset. In this instance, make settings again. Making settings may incur packet transmission fees.
- After the handset has been repaired, its MAC address for using Wi-Fi and its Bluetooth address may be changed regardless of the malfunction location.

- Note that a cash card or other magnetically sensitive item brought near the handset may become unusable.
- Although the handset is water-resistant, if water seeps into the interior of the handset or if moisture from humidity collects on the handset, immediately power it off, remove the battery pack, and it is recommended that you have the handset repaired at a DOCOMO specified repair office as soon as possible. However, repairs may not be possible depending on the condition of the handset.

Customer-created data and downloaded information

- When changing handset models or having the handset repaired, data the customer has created, loaded from an external source, or downloaded may be altered or erased. DOCOMO is not responsible whatsoever. Note that DOCOMO cannot reimburse the customer for packet communication charges resulting from redownloading data. DOCOMO may replace the handset with a substitute handset in lieu of repairs at DOCOMO's discretion. In this instance, with some data excepted, such data cannot be transferred to the substitute handset.

Software updates

A software update is functionality for updating the handset's software and allowing you to use it safely and enjoyably. This includes the following items — be sure the handset is updated with the latest software. A software update can be any of these 3 types.

- **Functionality addition**
Preinstalled apps and handset functions are updated to improve functionality and usability and allow smooth handset operation.
- **Quality improvement**
Preinstalled apps and handset functions are updated to improve quality and allow smooth handset operation.
- **Latest security patch update**
A patch (software for patching a vulnerability) is applied to allow more worry-free handset operation.

For details and time periods on software updates provided for the handset, see the NTT DOCOMO website. [ドコモのホームページ] (DOCOMO website) ▶ [お客様サポート] (Support) ▶ [サポート情報一覧] (Support Information List) ▶ [Android™製品のソフトウェアアップデート] (Software update for Android™ Products) ▶ [提供中の製品アップデート情報] (Current Product Update Information)
https://www.docomo.ne.jp/support/product_update/ (in Japanese only)

Updating software

Starting an update

Perform any of the following to start an update.

- From an update notification
From the status bar of the handset, select the notification and then start updating.
- From handset settings
In the standby screen, [ME] ▶ [Settings] ▶ [About phone] ▶ [Software update] ▶ [Check for update], and start the update.

Update procedure

Perform an update as follows. Follow the handset screen for instructions.

1 Download and install the update file

The confirmations "OK", "Later", or "Cancel" may appear before the update file is downloaded and installed. If a confirmation is displayed, select either of the following to proceed with the update.

(1) Select "OK"

Immediately download or install the update file.

(2) Select "Later"

Specify a time to start update and start downloading and installing the update file.

- To change this time later, in the standby screen, [ME] ▶ [Settings] ▶ [About phone] ▶ [Software update] ▶ [Auto update time settings], and set the time.

2 Restart the handset

- Once the update is ready, the handset restarts automatically.

3 Notification that the update is complete

- After the update completes successfully, a notification to complete the update appears in the status bar.

Important

- After software is updated, the handset cannot be returned to the previous software.
- Information unique to the handset (model, serial number, etc.) is sent to a DOCOMO server during a software update. DOCOMO does not use this information for purposes other than software updates.
- Functions become temporarily unavailable during a software update.
- If a SIM PIN is set, a SIM PIN entry window appears after software is overwritten and the handset is restarting. Enter the SIM PIN.
- If a software update fails and the handset becomes completely inoperable, bring the handset to a docomo-designated repair counter.
- Software cannot be updated in the following instances. Try updating software again after resolving the issue.
 - During a call
 - Date/time not set correctly
 - Battery too low
 - Free space in handset storage too low
 - During international roaming

- It is recommended to update software where signal conditions are good and without moving location. A software update may be interrupted if signal is weak.

Main specifications

Handset

Name	KY-43C
Size	Approx. 112 mm (H) x Approx. 51 mm (W) x Approx. 18.1 mm (D)
Weight	Approx. 124 g (When battery pack installed)
Display	Type: TFT Size: Approx. 3.4 inches Resolution (480 pixels width × 854 pixels height) (FWVGA)
Sub display	Type: Organic EL Size: Approx. 0.9 inches
Internal memory	ROM : 8 GB*1 RAM: 1 GB
Continuous stand-by time *2*3*4	LTE: Approx. 300 hours
Continuous talk time *4*5	VoLTE (AMR-WB): Approx. 420 min. VoLTE (HD+) (EVS-SWB): Approx. 420 min.
Charging time	AC Adapter O8: Approx. 130 min. (Desktop Holder KY01 use: Approx. 130 min.)
Wireless LAN	Supported standards: IEEE802.11b/g/n (2.4 GHz)*6*7 compliant

Bluetooth*8	Version: 5.1 Output: Bluetooth standard Power Class 1 Line of sight distance*9: Approx. 10 m Supported profile*10/Codec: HSP (1.2), HFP (1.7)*11, A2DP (1.3)*12, AVRCP (1.5), OPP (1.2), SPP (1.2), PBAP (1.2), PAN (PAN-NAP) (1.0), PAN (PANU) (1.0), MAP (1.2)
Video playback	Supported codecs: MPEG-4, H.263, H.264, VP8, VP9
Music playback	Supported codecs: AAC-LC, AAC+, eAAC+, AAC-ELD, AMR-NB, AMR-WB, FLAC, MP3, MIDI, Vorbis, PCM/WAVE, Opus
Languages	Displayed languages: Japanese and English Input languages (for typing): Japanese and English
Auto answering memo	Savable number: Up to 100 Maximum recording time per one item: Up to 60 seconds
Voice memo	Savable number: Up to 50 Max. recordable time per 1 memo: Up to 60 min.
Displayable redial numbers	Up to 50
Displayable received calls	Up to 50

- *1 The entire memory space cannot be allotted to saving downloaded data, etc. For usable free space, see "Storage" (→P.116).
- *2 Average usable time with the handset closed and in strong signal conditions at rest.
- *3 Continuous standby time depends greatly on current settings, surrounding conditions, frequency of calls/mail, etc.
- *4 If functions are used frequently, actual time may be less than half.
- *5 Continuous call time depends greatly on current settings, surrounding conditions, frequency of calls/mail, etc.
- *6 MIMO is unsupported.
- *7 MU-MIMO (client) is unsupported.
- *8 The handset and all Bluetooth® function-installed devices have ensured that they conform to the Bluetooth® specification according to the rules that the Bluetooth SIG defines, and are all authenticated. However, operating methods might differ or data might not be exchanged even when a connection is made, depending on the features or specifications of the connected device.
- *9 Differs with objects between devices and signal conditions.
- *10 Specifications according to purpose of use of the Bluetooth® devices, as stipulated by Bluetooth® standards.
- *11 Sound codecs mSBC (16 kHz) and CVSD are supported.

*12 Sound codecs SBC and AAC are supported.

Battery pack

Name	Battery Pack KY01
Battery	Lithium-ion battery
Nominal voltage	DC 3.8 V
Nominal capacity	1500 mAh

Specific Absorption Rate (SAR) Information of Mobile Phones

This model KY-43C mobile phone complies with the Japanese technical regulations and the international guidelines regarding human exposure to radio waves.

This mobile phone was designed in observance of the Japanese technical regulations regarding exposure to radio waves^(*1) and the limits of exposure recommended in the international guidelines, which are equivalent to each other. The international guidelines were set out by the International Commission on Non-Ionizing Radiation Protection (ICNIRP), which is in collaboration with the World Health Organization (WHO), and the permissible limits include substantial safety margins designed to assure the safety of all persons, regardless of age and health conditions.

The technical regulations and the international guidelines set out the limits of exposure to radio waves as the Specific Absorption Rate, or SAR, which is the value of absorbed energy in any 10 grams of human tissue over a 6-minute period. The SAR limit for mobile phones is 2.0 W/kg.

The highest SAR value for this mobile phone when tested for use near the head is 0.656W/kg^(*2), and that when worn on the body is 0.569W/kg^(*3). There may be slight differences of the SAR values in individual product, but they all satisfy the limit. The actual value of SAR of this mobile phone while operating can be well below the indicated above. This is due to automatic changes in the power level of the device to ensure it only uses the minimum power required to access the network.

This mobile phone can be used in positions other than against your head. By using accessories such as a belt clip holster that maintains a 1.5cm separation with no metal (parts) between it and the body, this mobile phone is certified the compliance with the Japanese technical regulations and the international guidelines.

The World Health Organization has stated that "a large number of studies have been performed over the last two decades to assess whether mobile phones pose a potential health risk. To date, no adverse health effects have been established as being caused by mobile phone use."

Please refer to the WHO website if you would like more detailed information.

<https://www.who.int/news-room/fact-sheets/detail/electromagnetic-fields-and-public-health-mobile-phones>

Please refer to the websites listed below if you would like more detailed information regarding SAR.

Ministry of Internal Affairs and Communications Website:

<https://www.tele.soumu.go.jp/e/sys/ele/index.htm>

Association of Radio Industries and Businesses Website:

<https://www.arib-emp.org/O1denpa/denpa02-02.html>

(in Japanese only)

NTT DOCOMO, INC. Website:

<https://www.docomo.ne.jp/english/product/sar/>

- *1 The technical regulations are provided in Article 14-2 of Radio Equipment Regulations, a Ministerial Ordinance of the Radio Act.
- *2 Including other radio systems that can be simultaneously used with LTE.
- *3 Including other radio systems that can be simultaneously used with LTE.

FCC Notice

This device complies with part 15 of the FCC Rules.

Operation is subject to the following two conditions:

- (1) This device may not cause harmful interference, and
- (2) this device must accept any interference received, including interference that may cause undesired operation.

Note:

This equipment has been tested and found to comply with the limits for a Class B digital device, pursuant to part 15 of the FCC Rules. These limits are designed to provide reasonable protection against harmful interference in a residential installation.

This equipment generates, uses, and can radiate radio frequency energy and, if not installed and used in accordance with the instructions, may cause harmful interference to radio communications.

However, there is no guarantee that interference will not occur in a particular installation. If this equipment does cause harmful interference to radio or television reception, which can be determined by turning the equipment off and on, the user is encouraged to try to correct the interference by one or more of the following measures:

- Reorient or relocate the receiving antenna.
- Increase the separation between the equipment and receiver.
- Connect the equipment into an outlet on circuit different from that to which the receiver is connected.

- Consult the dealer or an experienced radio/TV technician for help and for additional suggestions.

Warning

The user is cautioned that changes or modifications not expressly approved by the manufacturer could void the user's authority to operate the equipment.



FCC RF EXPOSURE INFORMATION

Warning! Read this information before using your phone.

Warning! Read this information before using your phone. In August 1996, the Federal Communications Commission (FCC) of the United States, with its action in Report and Order FCC 96-326, adopted an updated safety standard for human to radio frequency electromagnetic energy emitted by FCC regulated transmitters. Those guidelines are consistent with the safety standard previously set by both U.S. and international standards bodies. The design of this phone complies with the FCC guidelines and these international standards.

Body-worn Operation

This device was tested for typical body-worn operations with the back of the phone kept 0.39 inches (1.0 cm) from the body. To comply with FCC RF exposure requirements, a minimum separation distance of 0.39

inches (1.0 cm) must be maintained between the user's body and the back of the phone, including the antenna. All beltclips, holsters and similar accessories used by this device must not contain any metallic components. Body-worn accessories that do not meet these requirements may not comply with FCC RF exposure limits and should be avoided.

This device is not intended to be used with a lanyard or strap on the body. The device contains a mounting point that may be used to attach the device to equipment, a backpack or tool belt, etc.

Turn off your phone before flying

You should turn off your phone when boarding any aircraft. To prevent possible interference with aircraft systems, U.S. Federal Aviation Administration (FAA) regulations require you to have permission from a crew member to use your phone while the plane is on the ground. To prevent any risk of interference, FCC regulations prohibit using your phone while the plane is in the air.

■ FCC Certification Information

- The product is certified by Federal Communications Commission (FCC). The product's FCC ID is JOYEB1136.

You can view this certification in the following way.

How to confirm: In the standby screen,  [Settings] ► [About phone] ► [Compliance information]

Export Control Regulations

This product and its accessories may be subject to Japanese export control regulations ("Foreign Exchange and Foreign Trade Control Act" and related laws and regulations). They may also be subject to Export Administration Regulations of the US. Before exporting or reexporting this product and its accessories, necessary procedures must be followed at your responsibility and expense. For details, contact the Ministry of Economy, Trade and Industry of Japan or the US Department of Commerce.



Intellectual property rights

Copyrights/portrait rights

- Copyrighted contents you obtained from Internet websites using this product by downloading or other means, such as documents, images, software, are prohibited from reproduction, transformation and transmission over public lines without consent of the copyright holders, unless intended for personal use or any other purpose permitted by law. You should also refrain from disclosing portraits of other people using this product by such means as posting it on an Internet website without their consent because of possible infringement of their right of portrait.

Trademarks

- "FOMA", "dmenu", "mopera U", "ビジネスmopera", "デコメ[®]", "Deco-mail[®]", "WORLD WING", "公共モード", "WORLD CALL", "おまかせロック", "エリアメール", "イマドコ サーチ", "i-channel", "sp-mode", "Anshin Manager", the "dmenu" logo, the "i-channel" logo, the "Area Mail" logo, and the "docomo phonebook" logo are trademarks or registered trademarks of NTT DOCOMO, INC.
- "DIGNO" is a registered trademark of Kyocera Corporation.
- "Catch Phone (Call waiting service)" is a registered trademark of Nippon Telegraph and Telephone Corporation.

- The Bluetooth® wordmark and logos are registered trademarks owned by the Bluetooth SIG, INC. 
- Wi-Fi®, the Wi-Fi CERTIFIED logo, and Wi-Fi Direct® are registered trademarks of Wi-Fi Alliance. Wi-Fi CERTIFIED™, WPA™, WPA2™, and WPA3™ are trademarks of Wi-Fi Alliance. 
- Microsoft®, Windows®, and Windows® 10/Windows® 11 are registered trademarks of US Microsoft Corporation in the United States and other countries. The official name of Microsoft® Windows® is Microsoft® Windows® Operating System.
- The microSD and microSDHC logos are trademarks of SD-3C, LLC.
- iWnn IME from OMRON SOFTWARE Co., Ltd. is used for conversion methods for Japanese language, and for phrase prediction methods for English. iWnn IME©OMRON SOFTWARE Co., Ltd. 2009-2023 All Rights Reserved. THIS PRODUCT IS LICENSED UNDER THE MPEG-4 VISUAL PATENT PORTFOLIO LICENSE FOR THE PERSONAL AND NON-COMMERCIAL USE OF A CONSUMER FOR (i) ENCODING VIDEO IN COMPLIANCE WITH THE MPEG-4 VISUAL STANDARD ("MPEG-4 VIDEO") AND/OR (ii) DECODING MPEG-4 VIDEO THAT WAS ENCODED BY A CONSUMER ENGAGED IN A PERSONAL AND NONCOMMERCIAL ACTIVITY AND/OR WAS OBTAINED FROM A VIDEO PROVIDER LICENSED BY MPEG LA TO PROVIDE MPEG-4 VIDEO. NO LICENSE IS GRANTED OR SHALL

BE IMPLIED FOR ANY OTHER USE. ADDITIONAL INFORMATION INCLUDING THAT RELATING TO PROMOTIONAL, INTERNAL AND COMMERCIAL USES AND LICENSING MAY BE OBTAINED FROM MPEG LA, LLC. SEE [HTTP://WWW.MPEGLA.COM](http://www.mpegla.com).

THIS PRODUCT IS LICENSED UNDER THE AVC PATENT PORTFOLIO LICENSE FOR THE PERSONAL USE OF A CONSUMER OR OTHER USES IN WHICH IT DOES NOT RECEIVE REMUNERATION TO (i) ENCODE VIDEO IN COMPLIANCE WITH THE AVC STANDARD ("AVC VIDEO") AND/OR (ii) DECODE AVC VIDEO THAT WAS ENCODED BY A CONSUMER ENGAGED IN A PERSONAL ACTIVITY AND/OR WAS OBTAINED FROM A VIDEO PROVIDER LICENSED TO PROVIDE AVC VIDEO. NO LICENSE IS GRANTED OR SHALL BE IMPLIED FOR ANY OTHER USE. ADDITIONAL INFORMATION MAY BE OBTAINED FROM MPEG LA, LLC. SEE [HTTP://WWW.MPEGLA.COM](http://www.mpegla.com).

- Part of this product includes modules developed by Independent JPEG Group.
- The product contains fonts provided by LIM Corporation LTD.
- USB Type-C™ is a trademark of USB Implementers Forum.
- Other company and product names mentioned in this manual are trademarks or registered trademarks of their respective holders. The TM and ® marks are not indicated in this manual.
- All rights not indicated herein are those of their respective owners.

- The user is granted a license to use the software installed in the handset and described in this manual. Note the following when using the software.
 - (a) You must not copy, distribute, modify, analyze, reverse-engineer, or derive the source code of the software in its entirety or in part.
 - (b) You must not export the software in its entirety or in part in violation of law or regulation.
 - (c) No warranty is implied for the software's merchantability, fitness for any particular purpose, non-infringement of third-party intellectual property rights, etc. However, use of software included in the software is based on GNU General Public License (GPL), GNU Library/Lesser General Public License (LGPL) or other open-source software licenses and use of software under license to Kyocera Corporation is subject to the terms and conditions of each software license with priority.

For information on open-source software, see "■ Open-source software" as given expressly below.

■ Open-source software

This product contains open source software complying with licensing conditions of GNU General Public License (GPL), GNU Lesser General Public License (LGPL), and other open-source software. For specific conditions of GPL, LGPL, and other licensing, refer to "About phone" on this product. For details, see the Kyocera Corporation website.

This product contains software with copyrights belonging to Kyocera Corporation as well as software under license

to Kyocera Corporation. Copyrights to software contained in this product and designed/developed by Kyocera Corporation in compliance with the standards and licenses of open-source software are those of Kyocera Corporation and third parties, and the customer may not distribute, copy, modify, publicly transmit, etc. the software without the consent of Kyocera Corporation, except for any scope of use as permissible by copyright law or any scope of use as permitted separately by Kyocera Corporation.

License

[OpenSSL License]

Copyright © 1998-2011 The OpenSSL Project. All rights reserved.

This product includes software developed by the OpenSSL Project for use in the OpenSSL Toolkit. (<https://www.openssl.org/>)

THIS SOFTWARE IS PROVIDED BY THE OpenSSL PROJECT "AS IS" AND ANY EXPRESSED OR IMPLIED WARRANTIES, INCLUDING, BUT NOT LIMITED TO, THE IMPLIED WARRANTIES OF MERCHANTABILITY AND FITNESS FOR A PARTICULAR PURPOSE ARE DISCLAIMED. IN NO EVENT SHALL THE OpenSSL PROJECT OR ITS CONTRIBUTORS BE LIABLE FOR ANY DIRECT, INDIRECT, INCIDENTAL, SPECIAL, EXEMPLARY, OR CONSEQUENTIAL DAMAGES (INCLUDING, BUT NOT LIMITED TO, PROCUREMENT OF SUBSTITUTE GOODS OR SERVICES;

LOSS OF USE, DATA, OR PROFITS; OR BUSINESS INTERRUPTION) HOWEVER CAUSED AND ON ANY THEORY OF LIABILITY, WHETHER IN CONTRACT, STRICT LIABILITY, OR TORT (INCLUDING NEGLIGENCE OR OTHERWISE) ARISING IN ANY WAY OUT OF THE USE OF THIS SOFTWARE, EVEN IF ADVISED OF THE POSSIBILITY OF SUCH DAMAGE.

【Original SSLeay License】

Copyright © 1995-1998 Eric Young (eay@cryptsoft.com)

All rights reserved.

This product includes cryptographic software written by Eric Young (eay@cryptsoft.com)

THIS SOFTWARE IS PROVIDED BY ERIC YOUNG "AS IS" AND ANY EXPRESS OR IMPLIED WARRANTIES, INCLUDING, BUT NOT LIMITED TO, THE IMPLIED WARRANTIES OF MERCHANTABILITY AND FITNESS FOR A PARTICULAR PURPOSE ARE DISCLAIMED. IN NO EVENT SHALL THE AUTHOR OR CONTRIBUTORS BE LIABLE FOR ANY DIRECT, INDIRECT, INCIDENTAL, SPECIAL, EXEMPLARY, OR CONSEQUENTIAL DAMAGES (INCLUDING, BUT NOT LIMITED TO, PROCUREMENT OF SUBSTITUTE GOODS OR SERVICES; LOSS OF USE, DATA, OR PROFITS; OR BUSINESS INTERRUPTION) HOWEVER CAUSED AND ON ANY THEORY OF LIABILITY, WHETHER IN CONTRACT, STRICT LIABILITY, OR TORT (INCLUDING NEGLIGENCE OR OTHERWISE) ARISING IN ANY WAY OUT OF THE USE OF THIS SOFTWARE, EVEN IF ADVISED OF THE POSSIBILITY OF SUCH DAMAGE.

Index

A

About phone	115
Accessibility	119
Access points	110
Account	82
Account setting	115
After-sales service	147
Airplane mode	109
Air pressure hole	31
Alarm	91
Also vibrate for calls	102
Anshin Filter	131
Anshin Manager	114
Anshin Number Check	130
Anshin Scan	130
Anshin Security	130
Answering memo	
Playback	64, 68
Response	64
Settings	67
Any key answer	69
APN	110
App information	117
Application lock	106
Application lock number	105
App permission settings	57
Area Mail	128
Auto Answer	69

B

Back cover	32
Attaching	24
Removing	25
Backlight time	102
Backup	97
Battery care mode	114
Battery level	114
Battery pack	32, 47
Installing	47
Life	48
Removing	48
Battery saver	114
Block nuisance call	69
Bluetooth	125
Connection request	126
Disconnecting	126
Pairing	125
Passcode	125
Receiving data	127
Registration request	126
Sending data	127
Submenu operation	126
Unregistering	126
Bluetooth call	66
Bluetooth tethering	112
Bookmarks	87
Brightness level	102
Browser key	31
Bundled accessories	1

C	
Calculator	91
Calendar	90
Caller ID notification	69
Caller ID request	69
Call forwarding service	68
Call key	30
Call notification	69
Call settings	68
Call time	152
Call volume	65
Call waiting	68
Caring for the handset	26
Center key	30
Change SIM PIN	107
Charge time	152
Charging	48
AC adapter	49
DC adapter	52
Desktop holder	50
PC	52
Charging lamp	32、38
Check here first	142
Clear key	31
Connecting with a computer	123
Continuous standby time	152
Continuous talk time	152
Converting text	53
Copy	56、122
Copyrights	157

Correcting text	
Back function	53
Undo function	53
Countdown timer	93
Credentials	107
Cursor keys	30、33
Custom keys	31、59
Cut	56

D

d ACCOUNT password	105
d ACCOUNT setting	114
Data copy	122
Data management	122
Data switch	98
Data usage	111
Date setting	118
Deco-mail	76
Deleting from the schedule	91
Device admin apps	104
Device Control	52、98
Dial keys	30
Disaster Message Board	128
Display	30
Displaying history (web browser)	88
Display settings	101
dmenu	86
docomo general inquiries (ドコモ総合案内・受付)	71
docomo location information	114
docomo mail	75

Attachments	76
Creating	75
Deco-mail®	76
Receiving	77
Retrieving mail	77
Sending	75
Submenu	77
docomo repairs (ドコモ故障問合せ)	71
docomo service	114
Draining water	28
Drive mode	103
Dust resistance	23

E

Early warning "Area Mail"	128
Earpiece	30
Edit rejection SMS	69
Emergency calls	62
Enabling/disabling apps	117
Encryption	107
End key	31
English guidance	69
Entering emoji	55
Entering emoticons	55
Entering symbols	55
Erasing data	119
Error messages	146
Export Control Regulations	157
Extension line service	71
External connector terminal	31

External storage	45
------------------------	----

F

FAQ	142
File manager	123
Focus mode	35
Font size	101

G

GPS	117
-----------	-----

H

Handset memory	121
Handset menus	139
Homepage	86
Homepage setting	88

I

Incoming call settings	69
Incoming extension	69
Incoming history	66
Incoming lamp	32、38
Incoming LED	102
Incoming/outgoing settings	68
Initial settings	57
Input settings	56
Input settings (text entry)	56

Intellectual property rights	157
Internal Bluetooth antenna area	32
Internal GPS antenna area	32
Internal main antenna area	32
Internal storage	121
Internal sub antenna area	32
Internal Wi-Fi antenna area	32
International call	63

K

Kanji check	96
Key backlight	101

L

Languages & input	115
License	159
Location	117
Lock screen	106
Lock settings	104

M

Mail	
+Message	78
docomo mail	75
PC Mail	82
Mail account	82
Mail address (own)	40
Mail key	30

Main specifications	152
Managing tasks	58
Manner key	31
Manner mode	103
Material list	15
Memory capacity	152
Menu key	30
Microphone	31
microSD card	45
Installing	46
Removing	47
Missed calls	64
Mobile data	111
Mobile network	110
Mouthpiece	31
Moving data	122

N

nano SIM card	41
Installing	41
Removing	43
nano SIM card slot	32
Network restrictions	111
Network security code	105
Network service	68
Network settings	108
Notepad	94
Checking	94
Deleting	94
Registering	94

Notification icon	35, 36
Checking details	36
Notification settings	102
Notifications list	37
Notification sound	102

O

OfficeSuite	96
Open and Answer	69
Open source licenses	114
Open-source software	159
Operation password	104
Operation password setting	105
Outgoing call settings	68, 70

P

Pairing	125
Part names and functions	30
Passcode	125
Passwords	
d ACCOUNT password	105
Lock screen	106
Paste	56
PC Mail	82
Account	82
Attachments	83
Creating	82
Deleting	85
Displaying	84

Forwarding	85
Receiving	84
Replying	85
Sending	82
Setting	85
Personal Unblocking Key	105
Phone	60
Adding a call	65
Answering	63
Making a call	60
Operations during a call	65
Phonebook	71
Backup	73
Checking	72
Deleting	73
Edit	73
Groups	74
Mail	73
Making a call	73
Registering	71
Restore	73
Searching	72
SMS	73
Phone number (own)	39
Phrase	56
PIN	106
PIN Unblocking Key	105
Pointer operation	34
Pointer setting	115
Portrait rights	157
Power	
Off	52

On	52
Power key	31
Prediction conversion	53
Preferred network mode	110
Prefix settings	70
Profile	39
Public mode (power OFF)	69
PUK code	105
Pulse notification light	102

Q

Quick settings	120
----------------	-----

R

Record later	67
Redial	66
Registering schedule events	90
Reject anonymous call	70
Reject call setting	70
Rejecting a call	64
Sending SMS	64
Reject payphone call	70
Reject unknown call	70
Reject unregistered call	70
Remote operation	69
Reset	119
Text entry	57
Resetting access points	111
Resetting handset	119

Response message	67
Restore	97
Restrict data	108
Ringtone	102
Ringtone volume	63

S

SAR	154
Screenshot	39
SD card backup	96
Security codes	104
Application lock number	105
Network security code	105
Operation password setting	105
Personal Unblocking Key	105
PUK code	105
SIM PIN	105
Security settings	104
Select area	56
Set ring start time	69
Settings menu	101
Shock resistance	23
Shortcut	33
Silent mode	103
SIM card lock	107
SMS	
Rejecting a call	64
Software update	150
Sound recorder	94
Sound settings	102

Speaker	30
Specifications	152
Specified number rejection	70
Speed dials	61
Standby screen	35
Standby time	152
Status bar	35, 36
Notification icon	36
Status icon	37
Status icon	37
Step-up ring volume	69
Stopper	32
Stopwatch	93
Storage	116
Strap	40
Straphole	31
Sub-display	38
Switching characters	52

T

Tethering	112
Text entry	52
2-touch entry	54
Copy	56
Cut	56
Emoji	55
Emoticons	55
Input settings	56
Paste	56
Phrase	56

Prediction conversion	53
Reset	57
Select area	56
Submenu	56
Symbols	55
Time setting	118
Touch-tone signals	61
Trademarks	157
Transferring data	124
Troubleshooting	142

U

Unlocking the PIN	107
Usage restriction	106
USB settings	116
USB tethering	112
Used apps history	58

V

Vibration pattern	102
Virtual Private Network	113
Voice/answering memo key	31
Voicemail service	68
Voice memo	
Playback	64, 68
Recording start	66
Settings	67
VoLTE	60
Volume	103

Calling	65
Incoming	63
VPN	113

W

Wallpaper	101
Wallpaper settings	101
Warranty	147
Water resistance	23
Weather	95
Web	86
Web browser	86
Bookmarks	87
Copying text	87
dmenu	86
Download history	89
Entering URL	87
Homepage	86
Homepage setting	88
Operation	86
Save image	87
Searching	87
Tab operation	86
Text search	87
Web settings	88
Website viewing history	88
Website viewing history	88
Wi-Fi	108
Data usage	111
Detailed settings	109

Disconnecting	109
Wi-Fi Direct	109
Wi-Fi hotspot	112
Wireless settings	108
Working with files	121
WORLD CALL	63
World clock	93

Numeric

2-touch entry	54
+Message	78

The handset and etiquette

Please be considerate of those around you when using the handset.

Always power off the handset in these instances

■ When in a location where use is prohibited

For use onboard an aircraft or at a hospital, follow the instructions of the airline or facility. Power off the handset where its use is prohibited.

Set Public Mode in these instances

■ When driving

Be careful of using the handset while driving a vehicle. Other than where excepted by law, looking at handset screen or taking the handset in your hand to talk while driving are subject to prosecution.

■ When in a public location such as a live theater, movie theater, museum, or library

Using the handset can create a nuisance in public places where being quiet is the norm.

Be careful of where using the handset and the volume of your voice and ringtone

- Be careful of the volume of your voice when using the handset in a quiet place such as a restaurant or hotel lobby.
- When out and around, use the handset where not a hindrance to passers-by.

These functions help keep manners in public

The handset has convenient functions such as letting you not to have to answer calls and muting the handset.

● Manner mode (→P.103)

Mutes the handset.

● Public mode (power OFF) (→P.68)

Play guidance that you are where mobiles must be powered off, and then automatically disconnect the call.

● Handset vibration (→P.102)

Handset vibrates to notify you of incoming calls.

● Answering memo (→P.67)

Records callers' messages when you cannot answer the call.

- * Additionally, optional services such as voicemail service (→P.68) and call forwarding service (→P.68) are available.

Checking your charges, data volume and subscription, and carrying out various procedures etc. online

From the handset  ▶ Bookmarks ▶ dメニュー (dmenu) ▶ My docomo (in Japanese only)

From a PC My docomo(<https://www.docomo.ne.jp/mydocomo/>) (in Japanese only)

- You may not be able to access some website services due to system maintenance, your subscription, etc.
- To use "My docomo", "Network security code" or "ID/Password of d ACCOUNT" is required.

Inquiries from overseas (In case of loss, theft, unconnected, etc.)

(Business hours: 24 hours (open all year round))

■ From DOCOMO mobile phones

Display "+" on
the screen

-81-3-6832-6600 (toll free)

(to enter "+", press and hold "0".)

※ You can call using international call access code instead of "+".

■ From land-line phones

International call access
code for the country you stay

-81-3-6832-6600 (charges apply)

※ You are charged a call fee to Japan.

※ For international call access codes, refer to DOCOMO website.

- Please confirm the phone number before you dial.
- If you lose your handset or have it stolen, immediately take the steps necessary for suspending the use of the handset.
- If the handset you purchased is damaged, bring your handset to a repair counter specified by DOCOMO after returning to Japan.



We collect old phones, etc. regardless of brands and manufacturers.
Bring them to your nearest docomo Shop.

* Items to be collected: mobile phones, PHS, battery packs, chargers,
desktop holders (regardless of brands and manufacturers)



General Inquiries

Contact Us ▶



NTT DOCOMO website:

<https://www.docomo.ne.jp/support/inquiry/> (In Japanese only)

General Inquiries < docomo Information Center >

Business hours: 9:00 a.m. to 8:00 p.m. (open all year round)
Service available in: English, Portuguese, Chinese, Spanish.

■ From DOCOMO mobile phones

 (No prefix) **15770** (toll free)

* Only from a DOCOMO mobile phone or Smartphone.

■ From land-line Phones

 **0120-005-250** (toll free)

* May not be accessible from some IP phones.

■ From DOCOMO mobile phones

 (No prefix) **151** (toll free, in Japanese only)

* Only from a DOCOMO mobile phone or Smartphone.

■ From land-line Phones

 **0120-800-000** (toll free, in Japanese only)

* May not be accessible from some IP phones.



Don't forget your mobile phone... or your manners!

When using your mobile phone in a public place, don't forget to show common courtesy and consideration for others around you.

Sales: NTT DOCOMO, INC.

Manufacturer: KYOCERA Corporation

ahamo Subscribers

■ For Inquiries about Repair

ahamo website:

<https://ahamo.com/> (In Japanese only)



Repairs

Business hours: 24 hours (open all year round)
Service available in: English, Portuguese, Chinese, Spanish.

■ From DOCOMO mobile phones

 (No prefix) **113** (toll free, in Japanese only)

* Only from a DOCOMO mobile phone or Smartphone.

■ From land-line Phones

 **0120-800-000** (toll free, in Japanese only)

* May not be accessible from some IP phones.

- Please confirm the phone number before you dial.
- For Applications or Repairs and After-Sales Service, please contact the above-mentioned information center or check the docomo Shop etc. near you on the NTT DOCOMO website and contact.
- For online repair acceptance service, refer to DOCOMO website.
NTT DOCOMO website
<https://www.docomo.ne.jp/support/inquiry/repair/> (In Japanese only)



Inquiries for Business < docomo Corporate Information Center > (In Japanese only)

 **0120-003300**

Business hours: 9:00 a.m. to 5:00 p.m. (excluding Saturdays, Sundays, national holidays and New Year's holidays)

- Please confirm the phone number before you dial.

'23.2 (1.1 Edition)